

# Computer Science

## Grade 10



**Government of Nepal**

**Ministry of Education, Science and Technology**

**Curriculum Development Centre**

Sanothimi, Bhaktapur

# Computer Science

## Grade 10



Government of Nepal  
**Ministry of Education, Science and Technology**  
**Curriculum Development Centre**  
Sanothimi, Bhaktapur  
2076

**Publisher:**

**Government of Nepal**

**Ministry of Education, Science and Technology**

**Curriculum Development Centre**

Sanothimi, Bhaktapur

© Publisher

**Edition:**

2076 BS (2020 AD)

**Printing:**

**Janak Shikshya Samagri Kendra Limited**

Sanothimi, Bhaktapur

All rights reserved. No part of this publication may be reproduced, stored in a retrieval system or transmitted, in any other form or by any means for commercial purpose without the prior permission in writing of Curriculum Development Centre.

## Preface

The curriculum and curricular materials are developed and revised on a regular basis with the aim of making education objective-oriented, practical, relevant and job oriented. It is necessary to instill the feelings of nationalism, national integrity and democratic spirit in students and equip them with morality, discipline and self-reliance, creativity and thoughtfulness. It is essential to develop in them the linguistic and mathematical skills, knowledge of science, information and communication technology, environment, health and population and life skills. It is also necessary to bring in them the feeling of preserving and promoting arts and aesthetics, humanistic norms, values and ideals. It has become the need of the present time to make them aware of respect for ethnicity, gender, disabilities, languages, religions, cultures, regional diversity, human rights and social values so as to make them capable of playing the role of responsible citizens. This textbook for grade ten students as an optional Computer Science has been developed in line with the Secondary Level Optional Computer Science Curriculum, 2074 so as to strengthen knowledge, Skills and competencies on computer literacy. It is finalized by incorporating the recommendations and feedback obtained through workshops, seminars and interaction programmes.

The textbook is written by Mr. Sunil Kumar Gharti, Mr. Sushil Upreti and Mr. Bimal Thapa. In Bringing out the textbook in this form, the contribution of the Director General of CDC Dr. Lekha Nath Poudel is highly acknowledged. Similarly, the contribution of Prof. Dr. Shashidhar Ram Joshi, Dr. Dipendra Gurung, Ms. Pramila Bakhati, Mr. Nabaraj Paudel, Mr. Jagadish Bhatta, Mr. Dibakar Durdarshi is also remarkable. The content was edited by Mr. Yubraj Adhikari and Mr. Khil Narayan Shrestha. The language of this book was edited by Mr. Shankar Adhikari and Mr. Nabin Kumar Khadka. The layout of this book was designed by Mr. Khados Sunuwar. CDC extends sincere thanks to all those who have contributed in developing this textbook.

Efforts have been made to make this textbook activity-oriented, interesting and learner centered Curriculum Development Centre welcomes constructive feedback.



# Contents

S.N.		Page No
Unit 1.1	Networking and Telecommunication	1
Unit 1.2	Ethical and Social Issues in ICT	34
Unit 1.3	Computer Security	47
Unit 1.4	E-commerce	64
Unit 1.5	Contemporary Technology	73
Unit 1.6	Number System	83
Unit 2.1	Database Management System	103
Unit 3.1	Programming in QBASIC	150
Unit 3.2	Modular Programming	157
Unit 3.3	File Handling in QBASIC	187
Unit 4.1	Structured Programing in C	209



## Introduction

Information and Communication Technology is increasingly at the core of strategies aimed at securing the goals of sustainable development and stimulating economic growth around the world. Among others, these technologies are shaping the way of social interaction that takes place and public services are delivered in some fundamental ways.

The transmission of data and information from one place to another for the purpose of communication is known as telecommunication. The examples of telecommunication are mobile phone, Internet phone, television, landline, radio, etc. Network is an interconnection of different devices using wired or wireless media to exchange data and information.

From 1950 to 1980 AD, developed countries like Germany, England, France, America, etc. processed data by EDP (Electronic Data Processing Center). In Nepal, data was processed by National Computer Center (NCC). It was established in 1974 AD and processed data until 1996. Microcomputer was used to process national level census data by Central Bureau of Statistics in 1998 AD. Hotel booking, air ticketing, banking, email and Internet, etc. are services provided by use of computer and telecommunication after 1995 AD.

The group of computers all over the world is inter-connected through different media to transfer information. Nowadays, different types of computer network are used in private as well as government sector in Nepal.

The process of sending and receiving data and information between two or more than two people is known as communication.

## Data Communication Mode

Data communication is the process of transferring data and information between computers and other electronic devices. The two types of data communication are as follows:



### a. Simplex Mode

Simplex mode is the transmission of data and information that takes place in only one direction.

It is a unidirectional mode of data transmission.

Radio, newspaper, television broadcasting, books etc. are examples of simplex mode.

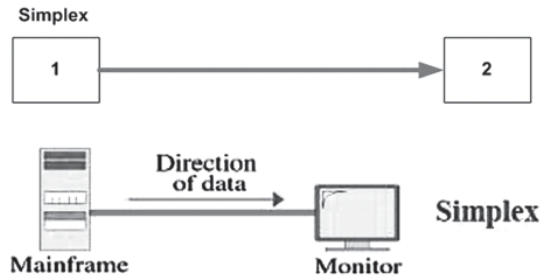

*Simplex Transmission Mode*

### b. Duplex Mode

Duplex is mode of data transmission in which data and information flow in both directions. It is bi-directional mode of data transmission. The two types of duplex modes are:

#### i. Half Duplex

Half-duplex is the mode of data and information that flows in both directions but only one direction at a time. Walky-talky and wireless handset are examples of half-duplex mode.

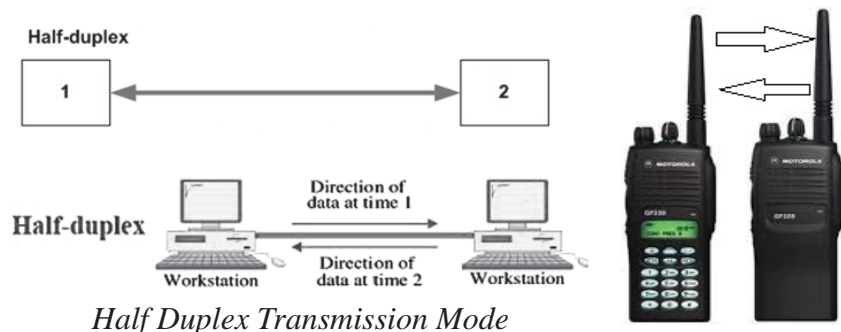

*Half Duplex Transmission Mode*

#### ii. Full Duplex

In full duplex mode, data and information flow in both direction simultaneously on the transmission path. Mobile and landline phones are examples of full duplex mode.

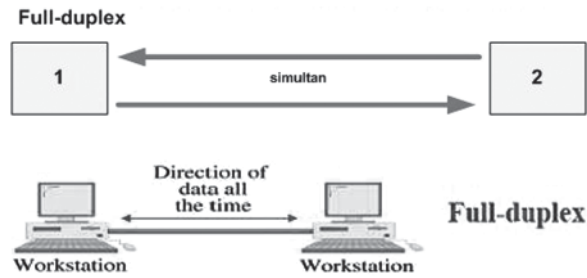

*Full Duplex Transmission Mode*

## Components of Data Communication

The five basic components (data, sender, medium, receiver and protocol) are required to make data communication.

**Data (message) :** Data is to be communicated between sender and receiver.

**Sender :** Sender is a device used to transfer data.

**Medium:** Medium is a channel through which sender and receiver make communication.

**Receiver:** Receiver is a device used to receive data.

**Protocol:** Protocol is a set of rules followed by sender and receiver.

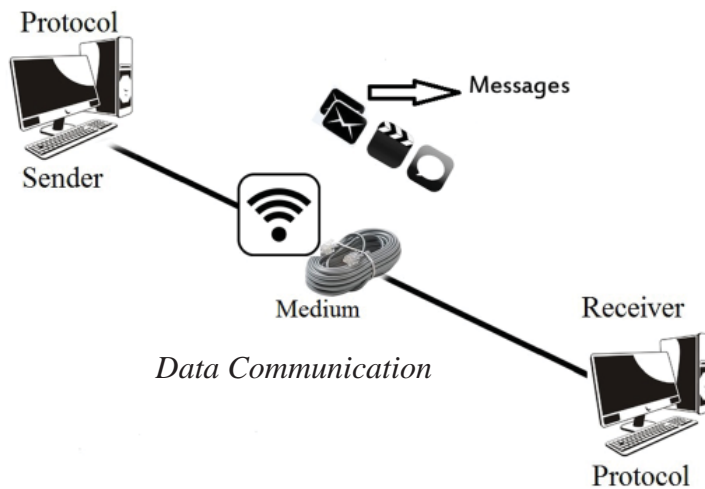

## Communication Media

A channel or path through which data and information are transmitted between connected devices in a network environment is called communication media. Communication media is also called transmission media. It acts as a communication channel for connecting different devices. Wire or wireless media is used for communication. The two main

types of communication media are:

1. Guided (Wired/bounded) communication media
2. Unguided (Wireless/unbounded) communication media

### **1. Guided (Wired/bounded) Communication Media**

The media which uses cable or wire to transfer data and information among computers are called guided communication media. This is an easy, fast and secure way to transfer data and information from one computer to another. The different types of wire or cable are used for a computer network. The three types of wire or cable are:

- a. Twisted pair Wire
- b. Co-Axial Cable
- c. Fiber Optic Cable

#### **a. Twisted Pair Wire**

Twisted pair wire is made of copper and a pair of wires are twisted together and insulated with plastic. It is commonly used in communication media. This is also widely used in landline telephone. RJ-45 connector is the most popular connector used in twisted-pair wire. The two types of twisted pair wire are:

##### **i. UTP (Unshielded Twisted Pair)**

Unshielded twisted pair cable or wire is most popular wire. This is used to transfer data and information in telephone connection. The cable without a shield is called unshielded twisted pair. Its grade starts from cat1 to cat7. It is easy, cheap and can cover a distance of 100 meters. The capacity of wire to transfer data from one computer to other is called bandwidth. Unshielded twisted pair has low bandwidth and measures in Mbps (Megabits per second).

##### **ii. STP (Shielded Twisted Pair)**

Shielded twisted pair is a wire woven with a copper shield. Cabling is more difficult to install and more expensive than UTP. Its bandwidth is 10 to 500 Mbps (Megabits per second). RJ 45 connector is used in STP. It provides better protection against EMI (Electromagnetic Interference) than UTP.

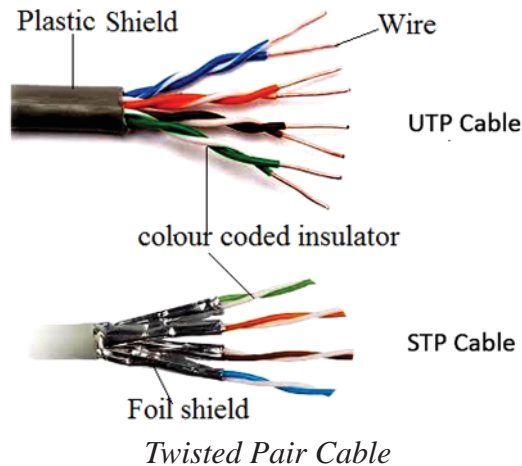

### b. Co-Axial Cable

Co-axial cable is made of copper or aluminium wire with an inner conductor surrounded by an insulating layer and again surrounded by conducting shield. So it consists of two conductors inner and outer conductors. It has high bandwidth and noise immunity. It is widely used in long-distance telephone lines. BNC and T connectors are the most popular connector used in co-axial cable.

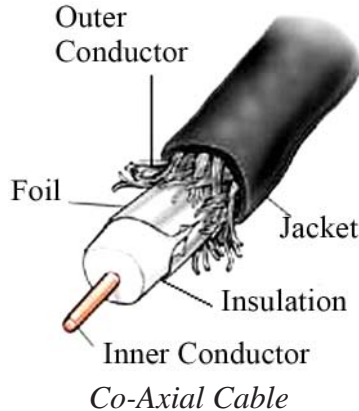

### c. Fiber Optic Cable

Fiber optic cable is made of plastic or glass fiber to transmit data. It uses light wave to carry data signal from one end of the cable to other end. It is of high quality and transmits data signals at very high speed. It is more powerful than twisted pair cable and co-axial cable. So it is widely used cable especially in ISP (Internet Service Provider). ST (Straight Tip) connector, SMA (Screw-Mounted Adaptors), SC (Subscriber Connector)

etc. are the common connectors used in fiber optic cable.

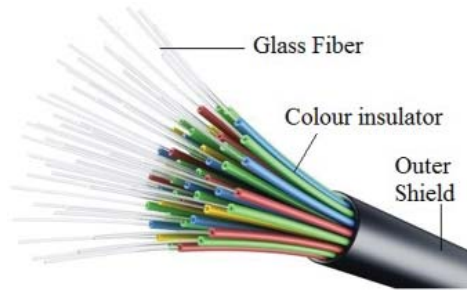

*Fiber Optic Cable*

## **2. Unguided (Wireless/unbounded) Communication Media**

Unguided communication is a communication channel in which data and information transferred between two devices without using wire or cable. Nowadays, wireless technology is used in communication technology. It uses radio signal for receiving and transmitting electronic data.

Permission for the use of wireless technology is to be taken from Nepal government. The three types of wireless communication are:

- Radio Wave
- Micro Wave
- Satellite Communication

### **a. Radio Wave**

Radio wave is an electronic magnetic wave. In Nepal, radio wave transmission is used in rural and hilly areas. The data and information can be changed into audio signals using high frequency wave on the basis of frequency, amplitude and phase modulation.

The wave is modulated due to its frequency change known as FM (Frequency Modulation).

The wave is modulated due to its amplitude change known as AM (Amplitude Modulation).

The wave is modulated due to its phase change known as PM (Phase Modulation).

So, radio wave is wave or pattern received after modulation of signals.

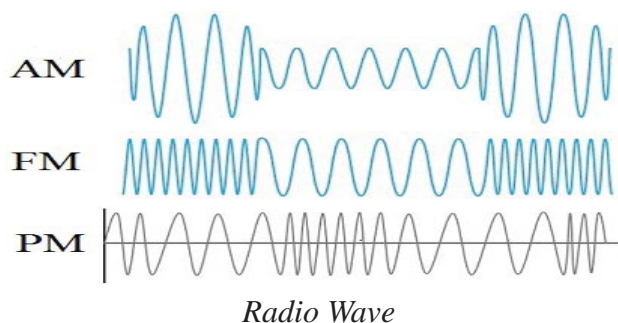

## b. Microwave

Microwave is high frequency wave which is used to transfer signals through atmosphere. It is also called line of sight communication. The microwave signal cannot bend or pass obstacles like hill and tall buildings. So transmitting and receiving devices should be in a clear line of sight fitted on very high towers, repeaters until to amplify the signal for long-distance communication in microwave. Digital modem and antenna are the important microwave devices.

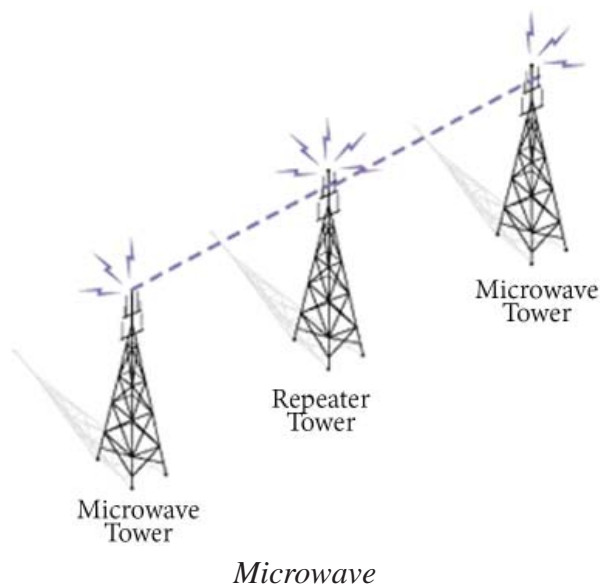

## Satellite Communication

Satellite communication is used to transfer information wirelessly worldwide after 1965. It is an artificial satellite placed in outer space for the purpose of telecommunication, radio, television, Internet, etc. Text, photo, video, etc. can be transferred worldwide using satellite communication. It is like microwave relay stations in the space or sky.

Nowadays, most of the countries use their own satellite to communicate.

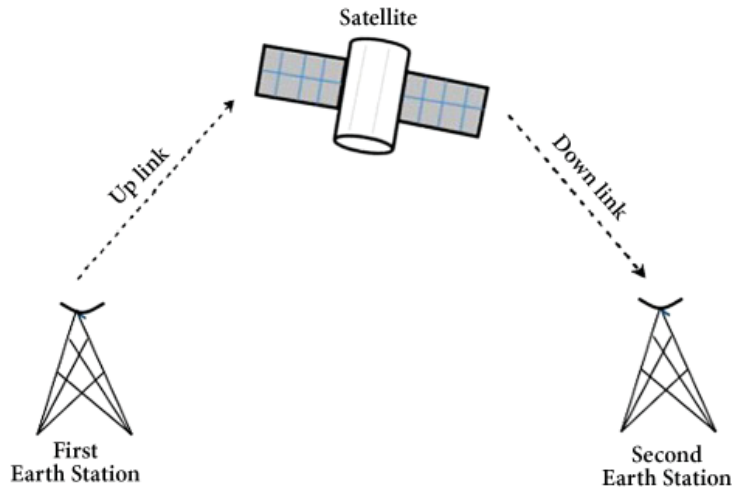

*Satellite Communication*

## **Computer Network**

Computer network is a group of two or more computers and devices connected to each other through wired or wireless media to exchange data and information and share hardware, software and other resources. In other word, the interconnection of many computers to share information is called computer network. It can share resources like scanner, printer, hard disk, operating system software, application software, etc. within the networking computer. The services provided by computer network are print service, message service, application service, file service, database service, etc.

### **Advantage of Computer Network**

1. A network connected computers can share hardware devices such as scanner, printer, hard disk, etc.
2. It can communicate and share information all over the world through Internet.
3. Computer network supports centralized administration.
4. Networking also provides the facility of data and software backup system.

### **Disadvantage of Computer Network**

1. Computer network can be route for computer virus and malware transmission.
2. Skilled manpower is required to manage and operate computer network.

3. The initial setup cost is very high to build computer network.
4. Cybercrimes are originated from computer network.

## Basic Elements of the Network

Nowadays, the use of computer network is growing all over the world. So a computer network is used for Internet, e-mail, chat, e-banking, etc. The hardware, software and medium are components of computer network. NOS (Network Operating System) and application software are the software used as network software. The hardware used in the network are computer set, modem, hub, NIC card, bridge, repeater, etc.

### 1. NIC Card

NIC stands for Network Interface Card. It connects all computers in network. It is placed on expansion slot of the motherboard. It provides a port on the back of system unit to connect a computer in network. It controls flow of data to and from computers in network environment. It is used in LAN (Local Area Network). Token ring and Ethernet are the examples of NIC card.



*NIC Card*

### 2. Connectors

Connectors are used to connect communication media with network devices. It provides data communication through NIC card. The different types of connectors are:

- RJ-45 connector for UTP cable
- BNC connector for co-axial cable
- ST connector for fiber optics cable



*RJ-45 connector*



*BNC connector*



*ST connector*

*Connector*



### 3. Hub

Hub is a network connectivity device with multiple ports for connecting different computers on network. It connects computers in star topology. It is simple, easier to install, low in cost, as compared to other devices. It can receive or send information between the computers. Nowadays, hub is replaced by a switch.



*Hub*

### 4. Switch

Switch is a network connectivity device which joins multiple computers together to share information among them. It co-ordinate file server and computers. The selected computer can get information through switch. It works faster than hub.



*Switch*

The difference between hub and switch are:

<b>Hub</b>	<b>Switch</b>
It is cheaper than switch.	It is more expensive than hub.
It transmits data slower than switch.	It transmits data faster than hub.

It broadcasts the information packets to all computer connected network.	It transfers packets to only those selected computers connected in network.
It is half duplex device.	It is full duplex device.

## 5. Bridge

Bridge is a network connectivity device that interconnects two computer networks having similar protocol. It inspects incoming signals and decides whether to forward or discard it. It connects similar networks.



*Bridge*

## 6. Router

Router is a network connectivity device that joins multiple wired or wireless networks together. Like a bridge, router also inspects and forwards data among different networks having similar protocol. It works on the principle of IP (Internet Protocol) address. It is an intelligent device that has ability to determine the best possible path for data transmission. Nowadays, different types of router are available in market.



*Router*

## 7. Gateway

Gateway is a network connectivity device that interconnects two networks having dissimilar communication protocols. It is also called protocol converters. It sends data in any network layer. Generally, it is more complex than a switch or router.

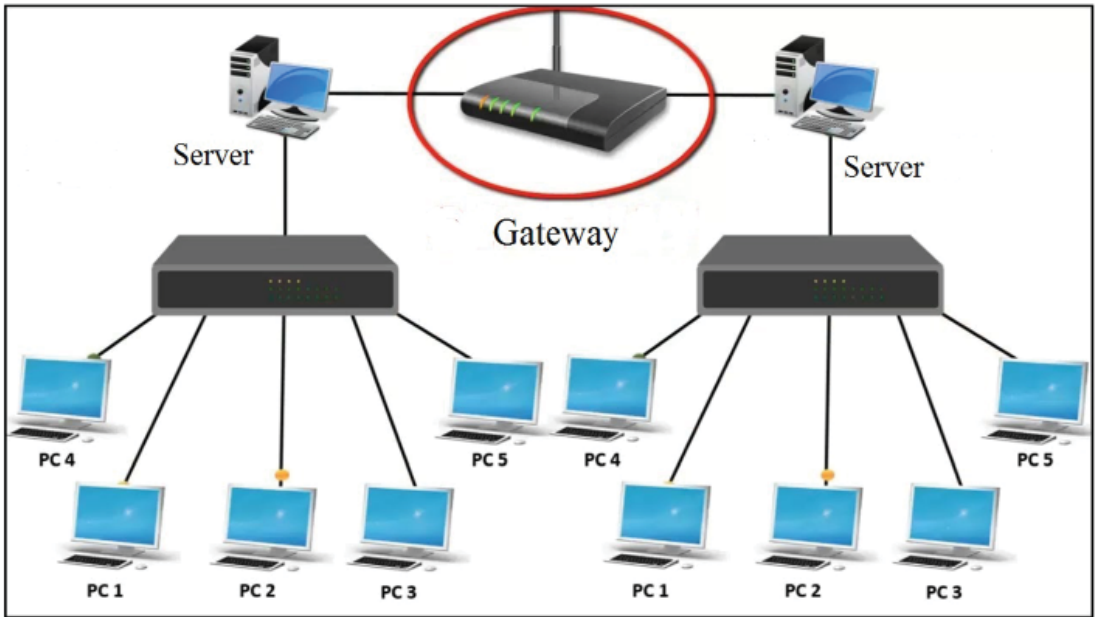

*Gateway*

## 8. Repeater

Repeater is a network connectivity device that accepts weak signals and regenerates them and after that sends the message on their way. It makes possible for long-distance data transfer. So it boosts the data signals that are received from network.

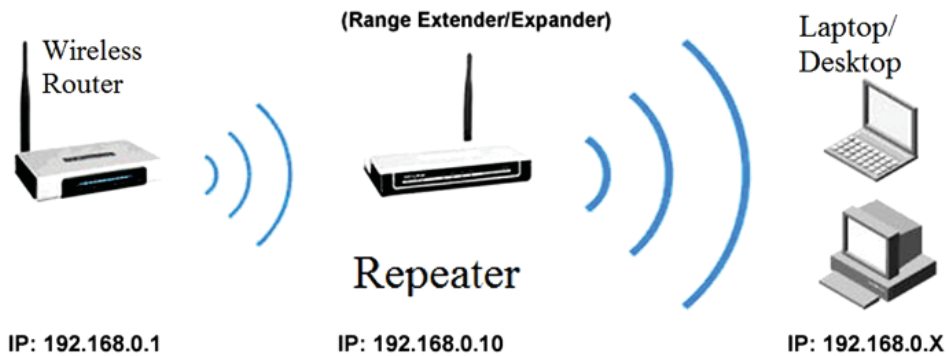

*Repeater*

## 9. MODEM

MODEM stands for Modulator and Demodulator. The MODEM turns the computer's digital signals into analog signals which are then transmitted across the phone line is called modulation phase. The MODEM receives analog signals from phone line and

converts into digital signals for the computer is called demodulation phase. It can convert analog signal to digital signal and the vice versa. So, it is a device which connects computers to ISP (Internet Service Provider) by the help of telephone line or router device. The MODEM which is placed inside the CPU Casing is called internal modem. MODEM which is placed outside the Casing is called an external modem.



*External MODEM*

## **Bandwidth**

The amount of data that can be carried from one point to another in a given time period is called bandwidth. It is measured in bits per second (bps). A MODEM that works at 57600 bps has twice the bandwidth of a MODEM that works at 28800 bps.

## **Network Software**

Network software is an important software which controls and manages computer network. It is also called NOS (Network Operating System). Novell Netware is a popular NOS. Windows NT, Windows XP, Linux, Banyan Vinex, etc. are other example of NOS. The main functions of NOS are:

- It helps to setup and install network.
- It allows administration to add or remove users from computer network.
- It enables users to have access to network resources.
- It manages and controls all the resources of computer network.

## Protocol

A set of rules followed for interconnection and communication between computers in a network is called a protocol. So it is rules followed while sending and receiving information using network software. NCP (Network Control Protocol) was the first protocol. Some common protocols are as follows:

- TCP/IP (Transmission Control Protocol/Internet Protocol) is used in Internet.
- HTTP (Hypertext Transfer Protocol) is used to transfer HTML documents in WWW.
- SMTP (Simple Mail Transfer Protocol) is used in sending e-mail.
- POP (Post Office Protocol) is used to retrieve e-mail from a mail server.
- FTP (File Transfer Protocol) is used to transmitting files between computers.

## Types of Network

Computer network can be classified according to its area covered. The main three types of computer network on the basis of geographical location (area covered) are:

1. LAN (Local Area Network)
2. MAN (Metropolitan Area Network)
3. WAN (Wide Area Network)

### 1. LAN (Local Area Network)

Local Area Network is a network limited within a small area like a room, a building, school, college, etc. generally connected through wire media. It can cover up to one kilometre for transferring data and information between the computers. It has high speed data transfer capacity than MAN and WAN. Computer in LAN can be connected through wireless media and is referred to as WLAN (Wireless Local Area Network). Computer lab networking and cyber networking are examples of LAN.

### Features of LAN (Local Area Network)

Coverage area is a generally small geographical area such as room, building and few kilometers.

- LAN runs the multiple devices to share a transmission medium

- The different topology used mainly bus and ring in LAN
- The communication quality is better in LAN, the transmission error rate are low as compare to WAN

LAN supports a variety of communications transmission medium such as an Ethernet cable (thin cable, thick cable, and twisted pair), fiber and wireless transmission.

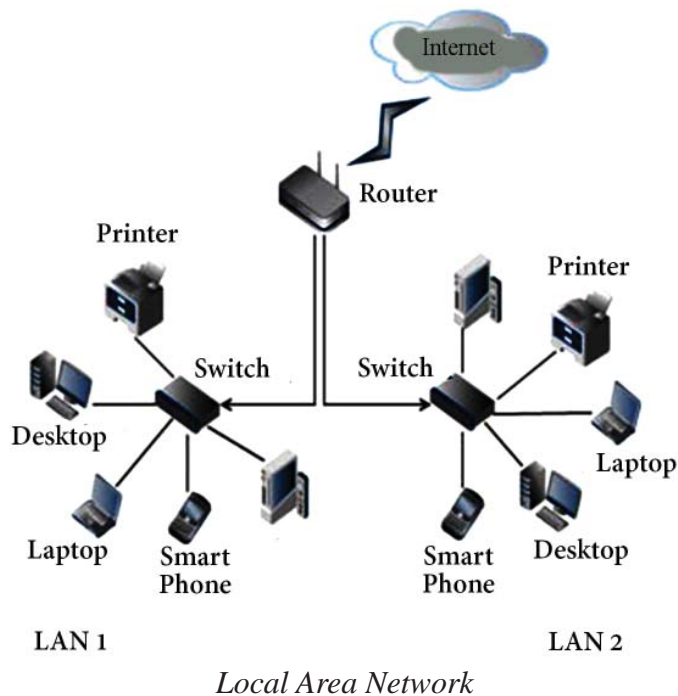

## 2. MAN (Metropolitan Area Network)

Metropolitan Area Network (MAN) is a network within the area like valley, city, metropolitan, etc. connected through wire or wireless technology or media. It covers more area than LAN and less area than WAN. It has high speed data transfer capacity than WAN and is slower than LAN. It is used in medium size organization having various branches within city or valley. Cable TV network and telephone networks providing high-speed DSL lines are examples of MAN.

### Features of MAN (Metropolitan Area Network)

- Network size up to 50 km. It may be as small as a group of buildings in a campus to as large as covering the whole city.

- It is normally owned by single or multiple organizations.
- It facilitates sharing of regional resources.
- They provide uplinks for connecting LANs to WANs and Internet.

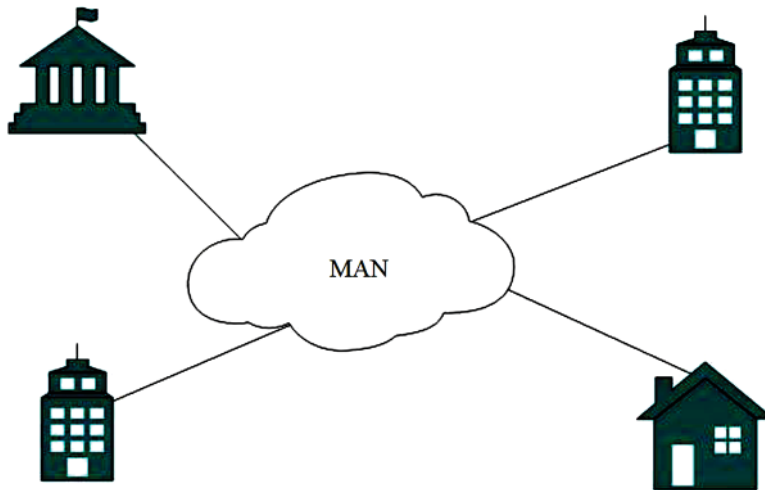

*Metropolitan Area Network*

### 3. WAN (Wide Area Network)

Wide Area Network is a network that is extended to a large area i.e. world in which computers are connected through wireless technology or media as satellite communication. It is the largest computer network. Internet, 4G Mobile Broadband Systems and satellite communication are the best examples of WAN.

#### Features of WAN (Wide Area Network)

- It covers the whole world and cannot be restricted to any geographical location. It uses satellite and microwave communication.
- It is normally owned by multiple organizations.
- Communication links are provided by public carriers like telephone networks, satellites, network providers, cable systems, etc.
- They have low data transfer rate and high propagation delay so they have low communication speed.



*Wide Area Network*

## **Network Architecture/Model**

Network architecture defines how the computer communicates and interacts with each other on network. It is combined form of topologies and data transmission mode between the different computers in the network. The three types of network architecture are:

### **1. Peer to Peer Network**

In this type of network, all nodes on the network have an equal relationship with each other. It is also called workgroup. It can share data, hardware and software with each other. It is suitable for a small area such as small offices, small room, building, etc. It uses many operating systems such as Windows 2000, Windows 8, Macintosh Operating System etc., have built-in features to support peer to peer network.

#### **Advantage of Peer to Peer Network**

- All resources and contentions can be shared in this network.
- System administrator is not required and each user can control their shared resources.
- The failure of one computer doesn't affect the functioning of other peers.

#### **Disadvantages of Peer to Peer Network**

- It is difficult for administrator and control as resources are decentralized in this



network.

- Security is very low in this system.
- Data recovery or backup is very difficult.

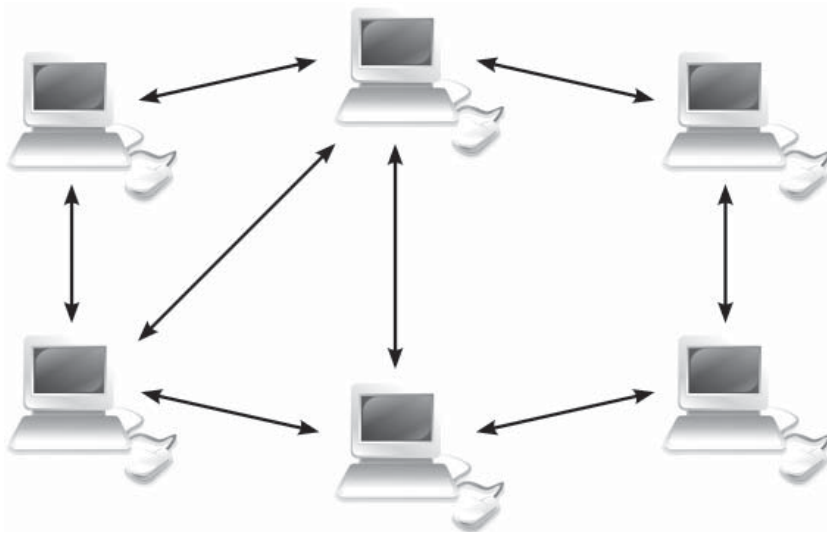

*Peer to Peer Network*

### **Client-Server Network**

A network model where one or more powerful computers (servers) provide the different network services and all other users of computer network (clients) access those services to perform user's tasks is known as client-server network. In such networks, there exists a central controller called server. A server is a specialized computer that controls the network resource and provides services to other computers in the network.

Novell Netware, Windows NT, Linux, etc. are the common examples of an operating system of client-server network.

### **Advantages of Client-Server Network**

- Centralized back up is possible in client-server computer network.
- The use of dedicated servers also increases the speed of sharing resources.
- Security is better in this network as all the shared resources are centrally administered.

### **Disadvantages of Client-Server Network**

- It requires specialized servers with large memory. This leads to an increase in the

cost.

- The cost of network operating system that manages the various clients is also high.
- It requires network administrator.

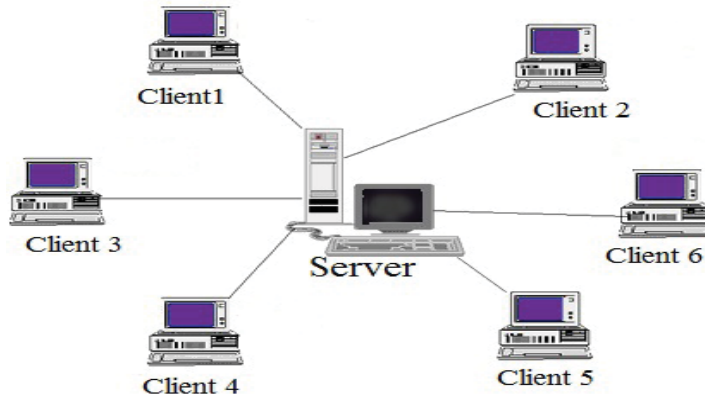

*Client-Server Network*

### **3. Centralized Network**

In this network, the main computer is known as host or server computer. Workstation is just used for input/output operations, which has no processing capabilities and are connected to server or host computer. Linux or UNIX operating system is used in centralized network.

#### **Advantages of Centralized Network**

- It saves cost of installation of network system.
- It secures all data and information on host computer which works on IPOS (input process output system).
- Host Computer gives facilities like Disk storage and software to workstation.

#### **Disadvantages of Centralized Network**

- The malfunctioning of host computer affects other workstation.
- It takes long time for data processing.
- It is difficult to add more workstation.

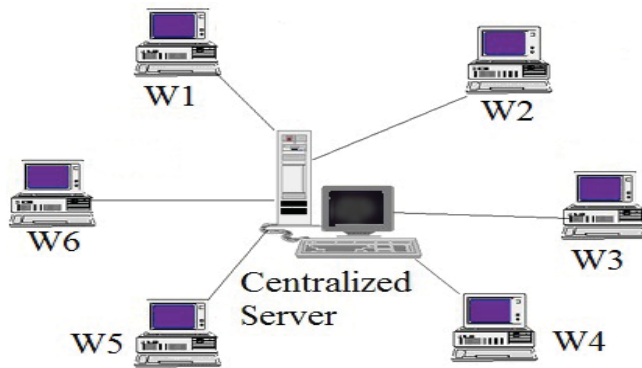

*Centralized Network*

## Topology

Network topology is the inter-connected pattern of network components. A network topology may be physical, mapping hardware configuration, or logical, mapping the path that the data must take in order to travel around the network. A LAN Topology is cabling structure or pattern of computers in local area. The three main types of topology are:

1. Bus Topology
2. Ring Topology
3. Star Topology

### 1. Bus Topology

This type of topology uses a segment of single cable to connect nodes. All nodes and network devices are connected to single cable called bus topology. Terminators are attached at the cable's start and end points. When it has exactly two end points, it is called linear bus topology.

#### Advantages of Bus Topology

- It is cost effective and cable required is least compared to other network topology.
- It is used in small networks and easy to understand.
- It is easy to expand networks.

#### Disadvantage of Bus Topology

- Break/Failure in main cable will make the whole network to malfunction.

- Heavy network traffic or increase in nodes will degrade performance of network.
- Terminators are necessary at both ends of the cable.

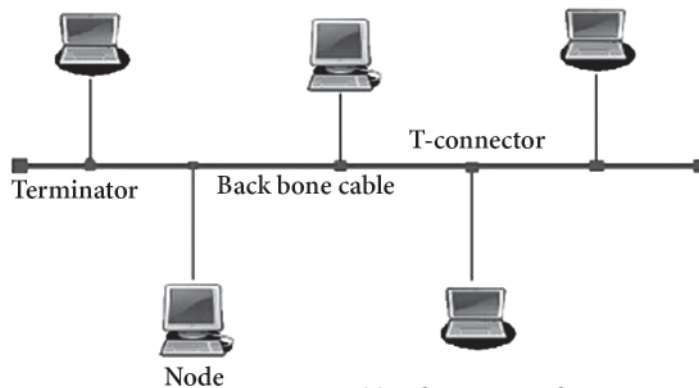

*Bus Topology*

## 2. Ring/Loop Topology

Ring topology forms a closed-loop as each computer is connected to another computer with the last one connected to the first is called ring topology. It uses fiber optic cable to transfer data. Each and every computer has equal responsibilities. A number of repeaters are used for Ring topology with large number of nodes. Data is transferred in a sequential manner.

### Advantages of Ring Topology

- In this topology all computers, in close loop, act as a client or server to transfer the information.
- Transmitting network is not affected by high traffic or by adding more nodes.
- It is cheap to install or setup and expand.

### Disadvantages of Ring Topology

- It is difficult for troubleshooting.
- In ring topology, adding or deleting the computers disturbs the network activity.
- Failure of one computer disturbs the whole network in this topology.

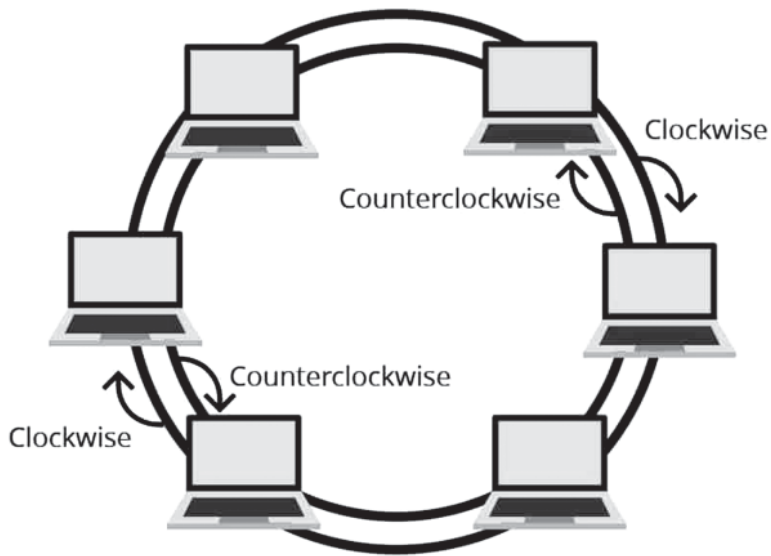

*Ring Topology*

### 3. Star Topology

It is a type of topology which connects all nodes to central device called hub/switch through a cable. It is probably the most common topology. Switch acts as a repeater for data flow. Star topology can be used with twisted pair, optical fiber and coaxial cable.

#### **Advantages of Star Topology**

- It provides fast performance and low network traffic.
- It is easy to troubleshoot setup and modify.
- The failure of one node has not affected the rest of the nodes.

#### **Disadvantages of Star Topology**

- Hub and more wires are required, so the cost of installation is high.
- The whole network is stopped when the hub fails.
- The system crucially depends on control device switch/hub. If it fails, entire network fails.

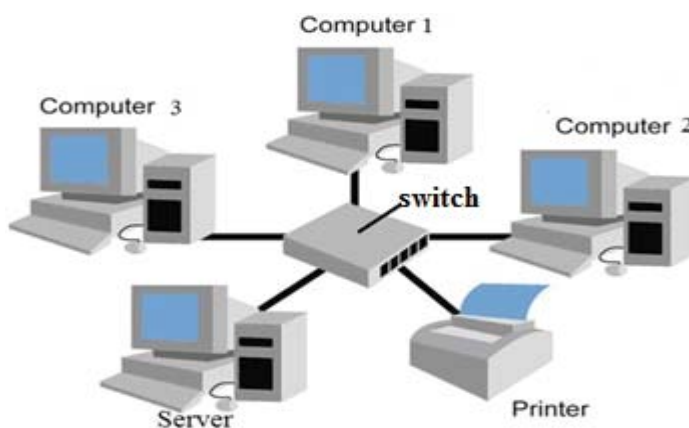

*Star Topology*

## **The Internet and its services**

Internet is a network of networks. The worldwide connection of computer networks that use TCP/IP protocols to communicate with one another using wire or wireless media as well as network devices is called the Internet.

Internet was originated in 1969 AD by ARPANET (Advanced Research Project Agency Network). ARPANET provides communication among various bodies of government which was developed by United States Department of Defense.

In 1992 AD, the Internet was openly used throughout the world. In Nepal, Internet service was started by Mercantile Company in 1994 AD.

## **Internet Services**

Internet is the interconnection of computers that are spread all over the world. It is used to get information and is used in many sectors such as education, business, entertainment, news, etc. The main internet services are as follows:

### **1. World Wide Web**

World Wide Web was developed by Tim-Berners-Lee of European Laboratory for Particle Physics; Switzerland in 1989 AD tested on 200 computers.

It is also called the web. It is a term used to describe the interlinked collection of hypertext documents and multimedia content available on internet. Web is a collection of internet host systems that make these services available on the Internet using the

HTTP (HyperText Transfer Protocol). Web document includes text, audio, video, graphic, etc. embedded. It is an information space where web document and web resources are identified by URL (Uniform Resource Locators). Web based information is usually delivered in the form of hypertext and hypermedia using HTML.

## 2. Email

E-mail stands for electronic mail. It is the most widely used service on the Internet. E-mail sends and receives messages electronically through the Internet. The message can be exchanged around the world using e-mail. It is very easy and quick means of communication. We can write an E-Mail message in mail programs like Eudora, Outlook Express, Netscape Navigator etc. and several web based programs like Yahoo mail, Hot mail, G mail and Zapak mail are also used for sending and receiving e-mails.

**E-mail address:** Each e-mail address is identified by a unique name. For example sarthak1@gmail.com. It has four parts they are as follows:

- sarthak1 : User's name
- @ (At the rate): A separator symbol
- gmail : domain name
- .com, .edu or .net : "commercial" "organization" or "network"



### Advantages of using E-mail

- It is the cheapest and fastest means of communication.
- It is more reliable than postal mail.
- E-mail can be accessed from any part of the world at any time.
- Information can be shared globally.
- We can send photos, songs, video clips and other file with e-mail attachments.
- A single mail can be sent to multiple people at a time.

## 3. Telnet (Teletype Network)

Telnet is the facility of Internet that allows user to use a remote computer through Internet. It was developed in 1969 AD. When it connects computer to the remote computers, the remote computer asks to enter user name and password. It can connect and interact

remote host or computer to your computer. Telnet is most likely to be used by program developers and anyone who has a need to use specific applications or data located at a particular host computer.

#### **4. FTP (File Transfer Protocol)**

File Transfer Protocol (FTP) is transmission files between computers on the Internet. It is a client/server protocol that relies on two communication channels between client and server as command channel for controlling the conversation and data channel for transmitting file content. Clients initiate conversations with servers by requesting to download a file. Using FTP, a client can upload, download, delete, and rename, move and copy files on a server. A user typically needs to log on to FTP server.

#### **5. Search Engine**

Search engine is the communication program that searches documents on the basis of specified keywords and returns a list of the web links that matches the keywords. Google, Ask, Alta Vista, Bing and Yahoo can search for files on WWW (World Wide Web). Search engines utilize automated software applications (referred to as robots, bots, or spiders) that travel along the Web, following links from page to page, site to site. The information gathered by the spiders is used to create a searchable index of the Web.

Nowadays, Google is the most used search engine. Google search engine available in Nepali language as well.



*Search Engine*

#### **6. IRC (Internet Relay Chat)**

IRC allows people from all over the world to communicate in real-time. Real-time communication means communicating with people in the immediate present time. There



are many different types of chats for different purposes. Internet chat rooms allow you to communicate with people from all over the world. Internet chats not only allow you to send and receive instant messages, they also allow you to share pictures, and files. Chatting service is provided by Face book messenger, yahoo messenger, Viber, etc. Video Conference helps to have face to face video chat. The main uses of a chat room are

- Communicate with expert, scientist, authors, etc.
- Brainstorming between students, colleagues and peers.
- Social and cultural experiences.
- Share ideas quickly regardless of distance.



*Chat*

## **7. Online Banking**

Online banking is also known as Internet banking or web banking. It allows a user to conduct financial transactions through Internet. It offers customers almost every service traditionally available through a local branch including deposits, transfers, and online bill payments. Virtually every banking institution has some form of online banking available both on desktop versions and through mobile apps. Online banking is fast and efficient. Convenience is a major advantage of online banking.

## **8. E-commerce**

E-commerce is also known as electronic commerce or Internet commerce. This means buying and selling of goods, products, or services through Internet. Transaction of money, funds, and data are also considered as E-commerce. These business transactions can be done in four ways: Business to Business (B2B), Business to Customer (B2C), Customer to Customer (C2C), and Customer to Business (C2B). Online stores like hamrobazar, alibaba, muncha, foodmandu, Amazon, Flipkart, Shopify, Myntra, Ebay, Quikr, Olx, etc. are examples of E-commerce websites.

## Summary

---

- The process of sending and receiving data and information between two or more than two person is known as communication.
- Simplex mode is transmission of data or information that can take place in only one direction.
- The five basic components (data, sender, medium, receiver and protocol) are required to make data communication.
- Twisted pair wire is made up of copper and a pair of wires are twisted together and insulated with plastic.
- Co-axial cable is made up of copper or aluminium wire with an inner conductor surrounded by insulating layer and again surrounded by conducting shield.
- Fiber optic cable uses light wave to carry data signal from one end of cable to other end.
- Nowadays, wireless technology is used in communication technology and uses radio signal for receiving and transmitting electronic data.
- In Nepal, radio wave transmission is used in rural and hilly areas.
- Microwave is high frequency wave which is used to transfer signals through atmosphere.
- Text, photo, video, etc. can be transferred worldwide by using satellite communication.
- Computer network is two or more than two computers connected to each other through wire or wireless media to share data or information, hardware, software and other resources.
- The hardware used in network are computer set, modem, hub, NIC card, bridge, repeater, etc.
- NIC card provides a port on the back of system unit to connect a computer in network.
- The different types of connectors are RJ- 45 connector, BNC connector and ST connector.

- Network software is important software which controls and manages computer network.
- A set of rules followed for interconnection and communication between computers in a network is called protocol.
- The main three types of computer network are LAN (Local Area Network), MAN (Metropolitan Area Network) and WAN (Wide Area Network).
- Network architecture defines how the computer communicates and interacts with each other on network.
- Network topology is the inter-connected pattern of network components.
- The world wide connection of computer networks and that uses TCP/IP protocols to communicate with one another using wire or wireless media as well as network devices is called Internet.
- The main Internet services are IRC, search engine, FTP, Telnet, E-Commerce, etc.

## Technical Terms

Duplex mode	: Data transmission in both directions.
Protocol	: A set of rules that are followed by computer network.
Fiber optic cable	: Made up of plastic or glass fiber to transmit data.
Radio wave	: Electromagnetic wave.
Repeaters	: Amplify the signal for long-distance communication in microwave.
Computer network	: The interconnection of many computers to share information.
Hub	: Network device with multiple ports for connecting computers.
Router	: Network device that joins multiple wired or wireless networks.
Repeater	: Network connecting device that boosts the data signals.
Network software	: Software which controls and manages computer network.
Internet	: Network of networks.
E-mail	: Sending and receiving messages electronically.

- FTP : Transmitting files between computers.  
Online banking : Internet banking or web banking.

## Exercises

### 1. Answer the following questions.

- a) What is a computer network? How it is useful?
- b) List any four advantages of Computer Network.
- c) Mention differences between client/server architecture and peer to peer architecture of the network.
- d) List out three disadvantages of computer network.
- e) Define bandwidth. How is it measured?
- f) Differentiate between LAN and WAN.
- g) "Internet is called network of network." Justify in your own language.
- h) Explain protocol with its examples.
- i) What are three models of Network? Write about client/server model of Network.
- j) What is network topology? Write about star topology with suitable diagram.
- k) Draw and briefly explain about client-server network.
- l) What is communication media? Differentiate between bounded and unbounded media.
- m) Give reasons that "Computer network reduces the cost of operation."

### 2. Write the full form of.

- |            |                  |            |          |            |
|------------|------------------|------------|----------|------------|
| i) ARPANET | ii) STP          | iii) UTP   | iv) SMA  | v) SC      |
| vi) NIC    | vii) MODEM       | viii) LAN  | ix) MAN  | x) WAN     |
| xi) TCP/IP | xii) HTTP        | xiii) SMTP | xiv) WWW | xv) POP    |
| xvi) FTP   | xvii) URL        | xviii) ISP | xix) ATM | xx) E-mail |
| xxi) E-fax | xxii) E-commerce |            |          |            |

**3. Give appropriate technical terms of the followings.**

- a) Data transmission in one direction only that is to send or receive only
- b) Device used to connect a PC with a telephone line
- c) A network limited with a room or building
- d) The computer on which users run applications
- e) Cabling structure of LAN
- f) Each computer or device on a network
- g) A device that controls two dissimilar networks
- h) The amount of data that can be transmitted through communication channels in a fixed time period
- i) A server where incoming emails are collected in mailbox
- j) A computer that provides services to other computer
- k) Operating system that can handle network
- l) A cable that transmits light signals
- m) Connection of two or more computers to share information
- n) The network of networks
- o) Sending and receiving messages electronically through the Internet
- p) Buying and selling of goods, products, or services over the Internet
- q) The websites that search documents for specified keywords in WWW
- r) A port on the back of the system unit to connect a computer in network

**4. Choose the correct answer**

- a. Which is not a communication media?  
i) wire                      ii) microwave      iii) satellite      iv) NIC
- b. A hub is connected in.....  
i) Ring Topology                                      ii) Bus Topology  
iii) Star Topology                                      iv) None of above
- c. A ..... is two or more LANs connected together, generally across a large geographical area.



- f) ..... can convert analog signal to digital signal and the vice versa.
- g) ..... is the popular NOS.
- h) ..... was the first protocol.
- i) ..... is a network within area like valley, city, metropolitan, etc. connected through wire or wireless technology.
- j) ..... is the central device and all other computers are connected to the central device.
- k) Internet was originated in ..... AD.
- l) World Wide Web was developed by .....

**6. Write short notes on:**

- a) Online banking
- b) E-Commerce
- c) E-Mail
- d) Switch
- e) Radio wave
- f) Protocol

## Project Work

1. Draw the “Types of computer network on chart paper” and paste in your classroom.
2. Collect the names of network used in different places like hospital, hotel, educational institute, etc. from your surrounding and demonstrate in a sheet of chart paper.
3. Prepare a presentation file on a topic “Types of topology used in Nepal” and demonstrate in your class.
4. Draw a typical diagram of computer network used in your computer lab or school.
5. Draw and explain about topology types used in your computer lab.
6. Prepare a PowerPoint Presentation file on the topic “Current trends of Internet and its use in Nepal”

## **Project Idea**

---

Choose one service that Internet has been providing to us or you can imagine or develop a new idea which is possible via Internet. Limit yourself with only one service and present in depth with all the required specificity. Your presentation may include multimedia files, graphics, cartoons, charts etc. Your presentation may include information in the following order:

### **Introduction**

Define/introduce that idea/history of idea/ summary of things you are going to present in this presentation

### **Main Body**

Its use/ beneficial aspects or target group that how it works, argumentation about do's and don'ts; relate human development in socio-economic prospects, benefits and limitations with examples

### **Conclusion**

Conclude your argumentation with logical interpretation and integrate it with human development



## Ethical and Social Issues in ICT

---

Ethics generally refers to the principles to make the decisions to lead our society or an individual for a better life. It is derived from the Greek word “ethos” which refers to character, guiding beliefs, standards or ideals that pervade (comes across) a group, community or people.

As ICT has totally dominated our lives, it has influenced our personal, social and moral values as well. As day by day more and more people are getting connected with the present digital world through the Internet which does not have a strong body to govern the rules and regulations to safeguard or guarantee the proper and improper usage of the technology. There are so many social networking sites; most of the people are connected to at least one such site, but we do not know exactly whether our personal information is properly maintained or not. This has created a lot of issues which has encouraged our digital society to focus on the ethics relating to ICT.

### 1.2.1 Computer Ethics

Ethics deals with placing a “value” on acts according to whether they are “good” or “bad”. Every society has its rules about whether certain acts are ethical or not. These rules have been established as a result of consensus in society and are often written into laws. When computers first began to be used in society at large, the absence of ethical standards about their use and related issues caused some problems. However, as their use became widespread

in every facet of our lives, discussions in computer ethics resulted in some kind of a consensus. Today, many of these rules have been formulated as laws, either national or international. Computer ethics is a set of moral principles or code of conducts that regulate the use of computers systematically without making harm to other users. It gives awareness to the user regarding the immoral behaviour and activities in the computing field.



Computer Ethics

Some important commandments of computer ethics are:

- Do not use a computer to harm other people.
- Do not use a computer to publish fake information.
- Do not search the file or record of other people.
- Do not destroy or delete the records of other people.
- Do not use a computer to steal someone's privacy.
- Do not interfere with other people's computer work.
- Do not snoop around in other people's files.
- Do not use or copy software for which you have not paid.
- Do not use other people's computer resources without authorization.

### 1.2.2 Cyber Ethics

Cyber ethics is a code of behaviour for using the Internet. It is acceptable behaviour on the Internet which is very much the same as acceptable behaviour in everyday life. For instance, at an early age, children learn what it means to be honest and to respect the rights and property of others. They are taught to not take what does not belong to them and to be considerate of others. On the Internet, the same basic rules apply.



Cyber ethics is distinct from cyber law. Laws are formal written directives that apply to everyone, interpreted by the judicial system, and enforced by the police. Ethics is a broad philosophical concept that goes beyond simple right and wrong, and looks towards "the good life". The objective of cyber ethics is to ESTABLISHING A CULTURE OF PROPER USE of the Internet and Computers.

Do's and Don'ts of cyber ethics

<b>DO</b>	<b>DON'T</b>
Do use the Internet to help you do your schoolwork.	Don't copy information from the Internet and call it your own.
Do use the Internet to learn about music, video and games.	Don't use the Internet to download or share copyrighted material

Do use the Internet to communicate with friends and family	Don't use the Internet to communicate with strangers
	Don't pretend to be someone else
	Don't be rude or use bad language
	Don't give anyone personal information or passwords

**Cyber ethics mainly deals with the following domains:**

- Privacy
- Property
- Security
- Accuracy
- Accessibility
- Censorship and Filtering

**1.2.3 Digital Citizenship**

Digital Citizenship refers to the use of technology as a measure of behaviour responsible for a digital society. Its importance is working in cyberspace and learning how to safely and legally compute. In this digital age, it is most necessary to be a digital citizen. Internet is used to connect people around the world. We can read text from a computer, smartphone or tablet. We can also connect with each other through social media. We act as digital citizens. Following are the elements of digital citizenship:



Following are the elements of digital citizenship:

- Digital Access: The state of full electronic participation in society
- Digital Commerce: The act of promoting the purchase of goods through electronic means
- Digital Communication: Electronic exchange of information
- Digital literacy: Teaching and learning about teaching and technology
- Digital Security: Electronic precautions

- Digital Health: The solution to health problems using digital technology
- Digital Law: Act, rules and regulations required for performing electrical work

### 1.2.4 Digital Footprint

Digital Footprint means the recording of interaction with the digital world. We leave behind the Digital Footprint trail using online technology.

These include digital cameras, i-pods, smartphones, laptops and computers. Therefore, a digital footprint is like an invisible report card which is stored for many years. This gives a general reflection of our online activity. Digital Footprints can be used for both good and bad purpose. The following should be considered when managing Digital Footprint:



- Subscribed accounts and unused social media accounts which are no longer in use should be unsubscribed or deleted.
- Ensure the content posted protect your privacy.
- Not to forget that online posts are private.
- To note that parents, teachers and other people can view the content posted.
- Ensure the content posted does not damage yours or others reputation.

### 1.2.5 Cyberbullying

Cyberbullying is bullying that takes place over digital devices like cell phones, computers, and tablets. Cyberbullying can occur through SMS, Text, and apps, or online in social media, forums, or gaming where people can view, participate in, or share content. Cyberbullying includes sending, posting, or sharing negative, harmful, false, or mean content about someone else. It can include sharing personal or private information about someone else causing embarrassment or humiliation. Some cyberbullying crosses the line into unlawful or criminal behaviour.



### **The most common places where cyberbullying occurs are:**

- Social Media, such as Facebook, Instagram, Snap Chat, and Twitter
- SMS (Short Message Service) also known as Text Message sent through cell phone
- Instant Message (via devices, email provider services, apps, and social media messaging features)
- Email

### **Examples of cyberbullying:**

- Sending rude emails, texts or instant messages online or on the phone
- Being excluded from online groups or forums
- Offensive chat on online gaming
- Posting hurtful things about someone on social media
- Spreading rumours or gossip about someone online
- Making fun of someone in an online chat that includes multiple people
- Attacking or killing an avatar or character in an online game, constantly and on purpose
- Pretending to be another person by creating a fake online profile
- Threatening or intimidating someone online or in a text message
- Taking an embarrassing photo or video and sharing it without permission

### **1.2.6 Cyber Law**

Success in any field of human activity in certain field, area of development and progress may simultaneously craft an offensive road as well to reach that success. That offensive mechanism surely needs mechanisms to control it. Legal provisions should provide assurance to users, empowerment to law enforcement agencies and



deterrence to criminals. With the development of the internet, the access of people in the computers worldwide has increased. It has provided many new opportunities. But

along with these new opportunities, there were people trying to take advantage of these developments to harm others. That is the reason cyber law is required. A law should not be considered as a tool to punish the wrongdoers but it is a tool to define how the activities shall be carried out which is acceptable to all stakeholders. Laws are prepared by the state and enforced by state machinery. Absence of proper law makes difficulty for the authorities to regulate and control the activities.

**Cyber law** describes the legal issues related to using of inter-networked information technology. Cyber law is a term that encapsulates the legal issues related to the use of communicative, transactional, and distributive aspects of networked information devices and technologies.

**Cyber law** is not one law but it is a set of different laws meant to control and regularize the activities taking place in the cyberspace. (Cyberspace is the virtual environment created by the Internet and devices and services related to the Internet.) Some leading topics of cyber law include hacking, intellectual property theft, credit card cloning, phishing, cyberbullying, privacy issue; freedom of expression, jurisdiction and the list goes on and on. To regulate the crime in this dimension of our life, governments come up with “Cyber Law.”

### 1.2.7 ICT Policy 2072

Information technology (IT) is the use of any computers, storage, networking and other physical devices, infrastructure and processes to create, process, store, secure and

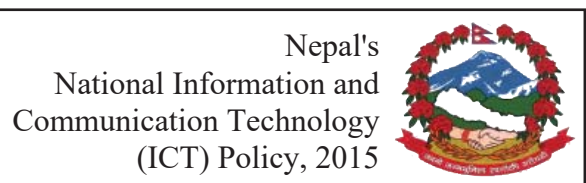

exchange all forms of electronic data. IT includes several layers of physical equipment (hardware), virtualization and management or automation tools, operating systems and applications (software) used to perform essential functions such as laptops, smartphones etc. Combination of information technology and telecommunication technology is called information communication technology (ICT). The government of Nepal revised the former policy and came up with the Information Communication Policy 2072 (2015) intending to regulate Information Communication

Technology as a whole. This policy emphasizes the need for a precise and consistent enactment and regulatory framework for addressing converged regime of telecommunications, broadcasting and ICT. The use of ICT can make the government more efficient and effective, facilitate more accessible government services, allow greater public access to information, and make government more accountable. It is the most cost-effective tool in improving public service delivery and government to government (G2G) communication.

This policy is primarily designed to guide and mainstream the use of ICTs in all sectors of the Nepalese economy within the overall context of socio-economic development and poverty reduction agenda pursued by the country. The policy states that appropriate programs will be developed and implemented to improve following sectors like education, agriculture, health, research and development, industry, promotion of e-Commerce, tourism, cloud computing, telecommunication and so on through the use of ICTs.

**The followings are the few goals the policy envisages to achieve:**

- Enhancement of overall national ICT readiness with the objective of being at least in the top second quartile of the international ICT development index and e-Government rankings by 2020
- 75 % of the population to have digital literacy skills by the end of 2020
- Universal broadband access to all people on an equitable basis to be in place. By 2020, 90 percent of the population to have access to broadband services
- The role and significance of ICT industries and services (including telecom services) to increase in the Nepali economy with ICT value added (including digital content and service industry) accounting for at least 7.5% of GDP by 2020
- Apex level institutional arrangement to be restructured to effectively drive ICT agenda in the country in the light of emerging technologies and application trends shaping the sector
- By 2020, entire population of Nepal to have access to Internet
- 80% of all citizens facing government services to be offered online by 2020
- e-Procurement to be promoted as means of driving transparency through

government procurement processes covering all public procurement of goods and services irrespective of cost and volume of such procurements by 2018

- G2G implementation to be promoted with a view to achieve complete automation of the operations of land administration, revenue administration and management, vital registration, passport and citizenship certificate services by 2020

### **1.2.8 Electronic Transaction Act (ETA)**

Electronic Transaction Act (ETA) deals with issues related to cybercrime and also help in making and implementing laws over cybercrime. It has made different requirements so that if anyone found committing cybercrime, he/she will be punished according to the nature of the crime.



The legal provisions for authentication and regularization of the recognition, validity, integrity and reliability of generation, production, processing, storage, communication and transmission system of electronic records by making the transactions to be carried out by means of electronic data exchange or by any other means of electronic communications, reliable and secured and for controlling the acts of unauthorized use of electronic records or of making alteration in such records through the illegal manner ETA has been enacted to regulate electronic business.

The house of representative (HoR) of the government of Nepal approved the electronic transaction act- 2063 on Mangsir 18, 2063 (December 4, 2006) and the era of electronic transaction is started in Nepal.

### **1.2.9 Opportunities and Threats in Social Media**

Social media is a process of performing a variety of tech-enabled activities via virtual communities and network. It plays a vital role in changing the way of people communicate and keep in touch. Social media includes activities such as photo sharing, blogging, social networks, video sharing, business networks, virtual worlds, etc. It also provides a platform to build career opportunities and share the thoughts, feelings,



insight and emotions. Social media is an important approach to digital marketing. It is an indispensable tool for business. Even governments and politicians use social media to engage with constituents and voters. Social media is continuously evolving with all marketing channels. It is providing tremendous opportunities for various brands to reach their customers. Some of the opportunities and benefits of social media are as follows:

### **i. Brand Development**

Branding is an important stage in any business that focuses on long-term business. Social media is a spectacular tool to grow a business. It allows customers to connect and interact with the business on a more personal level.

### **ii. Target Audience**

Social media is one of the effective platforms to reach the target audience. For example, 83% of social advertisers get connected to Instagram in order to attract a younger audience whereas 80% of social media leads come from LinkedIn.

### **iii. Customer Interaction**

Social media makes easy for brands to share the contents. It provides an easy platform to respond questions and feedbacks.

### **iv. Attracting Customer**

Social media can be a good way of attracting new customers. The customers can be attracted with various promotional or giveaway posts. Once you have a good following you can focus on more personalized social media campaign to encourage them to stay.

### **v. Research**

Social media helps to understand social consumers or market trends. Simply logging on to it you can see what your competitors are doing or finding out what your customers are saying about your brand may be a valuable exercise.

## **Social Media Threats**

### **i. Social Engineering**

One of the biggest threats of social media is social engineering. It allows attackers to

find personal information that can be used to target specific individuals.

## **ii. Targeted Phishing Attacks**

These attacks are carried out to steal money or certain confidential information. Targeted Phishing attacks are frequently successful as they focus on the organization's weakest point "Employee".

## **iii. Fake Accounts**

In July 2010, a fake profile named Robin Sage was made to request connections to random people, which most of them accepted without knowing who the woman was. The seriousness of such social media threats are underscored and is considered that the fake account, in this case, was successful in connecting thousands of peoples from various different fields.

## **iv. Social Media used for spreading spam and malware**

Certain users in social media are found sharing malicious contents. They create unwanted spam and are shared through chat, comments and more. The spam and malicious contents can appear in many forms such as bulk messages, hate speech, fake friends and many more

## **Summary**

---

- Ethics derived from the Greek word “ethos”.
- Ethics generally refers to the principles to make the decisions to lead our society or an individual for a better life.
- There are so many social networking sites, most of the people are connected to at least one.
- Computer ethics is a set of moral principles or code of conducts that regulate the use of computers systematically without making harm to other users.
- Cyber ethics is a code of behaviour for using the Internet.
- Laws are formal written directives that apply to everyone, interpreted by the judicial system, and enforced by the police.

- Hacking is generally considered as an illegal activity and the individuals who are engaged in hacking are called hackers.
- A digital citizen is a person utilizing information technology (IT) in order to engage in society, politics, and government.
- Digital Footprint means the recording of interaction with the digital world.
- Digital Footprint is like an invisible report card which is stored for many years.
- Cyber law describes the legal issues related to using of inter-networked information technology.
- Combination of information technology and telecommunication technology is called information communication technology (ICT).
- The government of Nepal revised the former policy and came up with the Information Communication Policy 2072 (2015)
- Electronic Transaction Act (ETA) deals with issues related to cybercrime.
- Social Media is an important approach to digital marketing.
- Governments and politicians use social media to engage with constituents and voters.

## Exercises

### 1. Answer the following questions.

- a) Define Information and Communication Technology.
- b) What is computer ethics? Write any two of them.
- c) Why is ethics important in information technology?
- d) Write any four commandments of computer ethics.
- e) What is hacking?
- f) What is the purpose of hacking?
- g) Define digital citizenship?
- h) What is a digital footprint?
- i) Write some of the examples of digital footprint.
- j) Define cyber bullying with any four examples.

- k) Share your thoughts about cyberbullying.
- l) Briefly explain cyber law.
- m) What is cybercrime?
- n) Define IT Policy 2012 in short.
- o) What is Electronic Transaction Act?
- p) Write any four opportunities and threats in social media.

**2. Fill in the blanks with appropriate word.**

- a) ..... is set of moral principles or code of conducts.
- b) ..... is a code of behaviour for using the Internet.
- c) The state of full electronic participation in society is .....
- d) ..... is a term that encapsulates the legal issues.
- e) Digital Footprint means the recording of interaction with the .....
- f) NIC stands for.....
- g) Combination of information technology and telecommunication technology is called .....
- h) ..... deals with issues related to cybercrime.
- i) ..... is a process of performing variety of tech-enabled activities via virtual communities and network.

**3. Write the full form of.**

- i) IT      ii) ICT      iii) G2G      iv) E-commerce      v) ETA

**4. Give appropriate technical terms of the followings:**

- a) A set of moral principles or code of conducts that regulate the use of computers
- b) A code of behaviour for using the Internet
- c) The use of technology as a measure of behaviour responsible for digital society
- d) The recording of interaction with the digital world

- e) The legal issues related to using of inter-networked information technology
- f) The issues related to cybercrime and also help in making and implementing laws over cybercrime
- g) A process of performing a variety of tech-enabled activities via virtual communities and network

## Project Work

---

1. Make a PowerPoint presentation in a group and present it in the class “**How can we prevent cyberbullying and stay cyber-safe**”.  
[You will have to do much interviewing with the colleagues in your school.]
2. Prepare a presentation file on a topic “**IT policy 2072 and Electronic Transaction Act (ETA)- 2063**” and present in your class.
3. Explain “**Opportunities and Threats in Social Media**” in a sheet of chart paper.
4. Prepare a presentation file on a topic “**Cyber law of Nepal**” and present in your class.
5. Prepare a presentation file on a topic “**Computer ethics and its important commandments**” and demonstrate in your class.

# Computer Security

---

## Introduction

Computer has become inseparable from our life. It is not only different types of computers that have become part of our life but smaller devices like smartphones and gadgets have become an integrated part of our life. It has opened the door to an infinite amount of information stored in the clouds and, thus, many opportunities.



Computer is no more a machine sitting on our desk or our lap. There is no sector of society where computer or information technology related products are not used. It is now a part of the global system of cyber. Almost all the computers are connected through the Internet. When we are talking about computer, now, we are talking about the cyberspace where the interconnection of computers throughout the world makes a virtual world of information system.

Computer security means protecting our computer and its content from damage, theft or misuse and action to prevent such incidents. The expansion and interconnection of computing system globally has also increased threat in computer security. Nowadays, computer security becomes a part of broader cyber security. At the present time, almost everything is connected to the Internet and provides services online which include banks, government offices, universities, companies and almost everything. This increases the motivation of the culprits to steal information, resources and even money from the banks. That has also increased the need of knowledge about cybersecurity, commitment to abide by it and legal provisions to prevent and penalize crimes related to the cyber world. Computer security includes security of:

- data and information – stored or being transferred
- computer programs and applications
- credentials

- computer hardware

Let's discuss about them here.

### 1.3.1 Information Security

We use computers to process different types of data, store them, share and transfer them. Data and information are we can say, the purpose of we using computer systems. It is crucial that the data and information stored in the computer system are protected and they are securely transferred to or shared with intended person or place without interference or theft.



First, let's talk about the security of stored data. We store data in our computer's hard disk – also in CD, DVD or pen drives at times. The data should be protected from loss or unauthorized access. The data is lost when we accidentally delete, our hard disk crashes or the whole computer is damaged due to fire, flood or natural calamities or the machine is stolen.

#### We can protect our data:

- by periodically checking the hard disk and replacing it if it shows failure symptoms;
- by copying the data in another disk in the system to avoid accidentally erasing or erasing data by unauthorized person;



- Nowadays, we can copy important data into online storage devices which is also called cloud storage. There are many providers who provide space in the cloud for online storage of our data which include Dropbox, Google Drive, OneDrive, iCloud. Some of them are free up to the certain size of storage space.

- We can also, sometimes, send important files as an attachment to our own mail such as Gmail or Hotmail.
- Another issue of protecting data is preventing them from authorized access. Unauthorized users may access our data store in our computer in the cloud storage. To prevent our data from unauthorized access we have to protect the storage space, folder or file with password.

### i. Security Threats

There are computer security threats which can risk program, data and information at the local computer and in the clouds. So, we discuss them here as Cyber Security Threats and in the next section, we will discuss some measures to protect from these threats.

- a) **Phishing:** Phishing is the fake attempt to obtain sensitive information such as usernames, passwords and credit card details by disguising oneself as a trustworthy entity in an electronic communication. Typically carried out by email spoofing or instant messaging,



it often directs users to enter personal information at a fake website which matches the look and feel of the legitimate site. It could involve an attachment to an email that loads malware onto your computer. It could also be a link to an illegitimate website that can trick you into downloading malware or handing over your personal information.

- b) **Botnet:** A botnet is a logical collection of Internet-connected devices such as computers, smartphones or internet of things (IoT) devices whose security have been breached and control is given away to a third party. Each compromised device, known as a

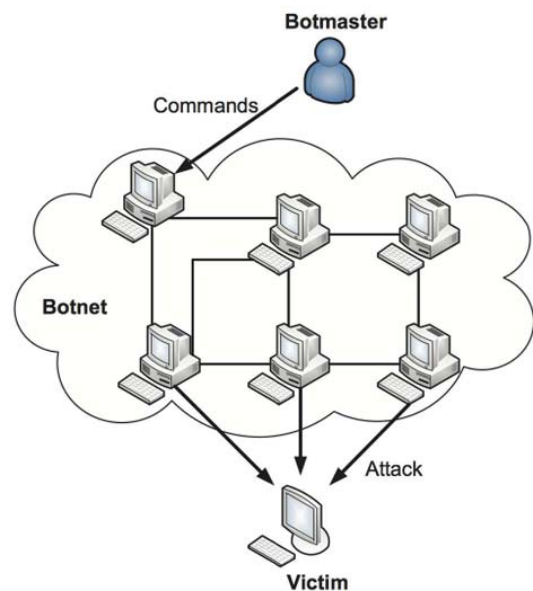



"bot", is created when a device is penetrated by software from a malware (malicious software) distribution. The controller of a botnet is able to direct the activities of these compromised computers through communication channels formed by standards-based network protocols, such as Hypertext Transfer Protocol (HTTP). Botnets are increasingly rented out by cybercriminals as commodities for a variety of purposes.

- c) **Rootkit:** A rootkit is a malicious code (kit) that hides in system area provides continued Administrator's (root) privileged access to a computer while actively hiding its presence. Once a rootkit has been installed, the controller of the rootkit has the ability to remotely execute files and change system configurations on the host machine. A rootkit on an infected computer can also access log files and spy on the legitimate computer owner's usage.

- d) **Keylogger:** Keylogger is hardware or software for recording the keys pressed on a keyboard secretly so that person using the keyboard does not know that their actions are being



monitored. Data can then be retrieved by the person operating the logging program. While the programs themselves are legal, with many of them being designed to allow employers to oversee the use of their computers, keyloggers are most often used for stealing passwords and other confidential information.

- e) **Hacker:** A computer hacker is any skilled computer expert who uses his/her technical knowledge to overcome a problem. While "hacker" can refer to any skilled computer programmer, the term has become associated in popular culture with a "security hacker". Security hackers are people involved with circumvention of computer security. Among security hackers, there are several types, including Whit hats, Black hats and Grey hats hackers.



- f) **Drive-by attack:** Drive-by download attacks are a common method of spreading malware. Hackers look for insecure websites and plant a malicious script into HTTP or PHP code on one of the pages. This script might install malware

directly onto the computer of someone who visits the site, or it might re-direct the victim to a site controlled by the hackers. Drive-by downloads can happen when visiting a website or viewing an email message or a pop-up window. Unlike many other types of cyber security attacks, a drive-by doesn't rely on a user to do anything to actively enable the attack — you don't have to click a download button or open a malicious email attachment to become infected. A drive-by download can take advantage of an app, operating system or web browser that contains security flaws due to unsuccessful updates or lack of updates.

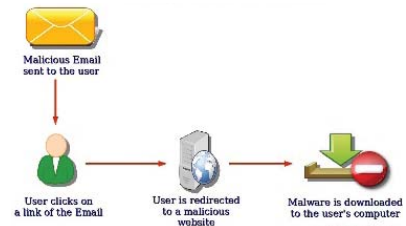

To protect yourself from drive-by attacks, you need to keep your browsers and operating systems up to date and avoid websites that might contain malicious code.

## ii. Malicious codes

Malicious code is the kind of harmful computer code or web script designed to create system vulnerabilities leading to back doors, security breaches, information and data theft, and other potential damages to files and computing systems. It's a type of threat that may not be blocked by antivirus software on its own. It is an auto-executable application that can activate itself and take on various forms, including Java Applets, ActiveX controls, pushed content, plug-ins, scripting languages or other programming languages that are designed to enhance Web pages and email.



The code gives a cybercriminal unauthorized remote access to the attacked system — called an application back door — which then exposes sensitive company data. By unleashing it, cybercriminals can even wipe out a computer's data or install spyware.

### 1.3.2. Security mechanisms

#### i. Authentication System

The process of identifying an individual usually based on a username and password is called an authentication system. In security systems, authentication is distinct from

authorization, which is the process of giving individuals access to system objects based on their identity. Let's discuss about the different authentication system:

### a. Password

A password is a memorized secret used to confirm the identity of a user. In general, a password is a string of characters including letters, digits, or other symbols. If only numbers are allowed in the secret code, then it is called a Personal Identification Number (PIN). In computer system password normally comes with a username. The combination of username and password that is used to access a resource is offer called credentials. Credentials are required to gain access to our email, restricted sites, banks website to manage our account, open our computer, and so many other places. We have to keep the password secure and strong so that unauthorized users may not gain access to the resource and misuse it with our identity. Following are some of the tips to make our password secure and strong:



- Never share your credentials online.
- Don't use easily guessable the name of a pet, child, family member, birthdays, birthplace, name of a favourite holiday.
- Don't use a sequence like abcd or 1234 which are, again, easily guessable.
- Mix characters, numbers and symbols. Also, mix small and capital letters.
- Avoid using the same password in all applications.
- Change password periodically.

### b. Biometric

Nowadays, the character or numeric passwords are being replaced by biometric authentication. Fingerprints, face detection or retina detection are being used as biometrics authentication. Biometrics authentication is considered more secure than string password.



### c. Firewalls

When it comes to preventing unauthorized access of the third party in a private network, firewalls are used. A firewall is the network security systems that monitors and

controls the traffic flow between the Internet and private network or private computer on the basis of a set of user-defined rules. Firewalls shelter the computer network of an organization against unauthorized incoming or outgoing access and provide the best network security. Firewall can be a hardware firewall, software firewall or firewall incorporated in Operating System such as Windows Firewall. An OS incorporated firewall is a component of the Operating System and we can enable its operation by turning its access on. We can enable Windows firewall in our computer to protect it from unwanted traffic from the Internet.

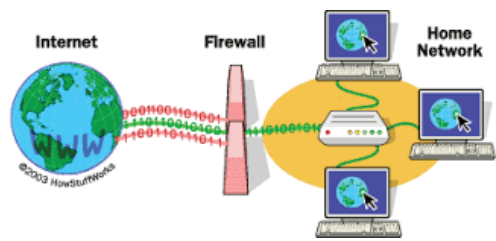

#### d. Cryptography

We share data and information with other people and institutions through the Internet. There are many ways we can share files- we can send them as email attachments, we can share them from online storage spaces. We can also share them from websites. There are data presented in the form of webpages, downloads from and upload to the HTTP or FTP sites and exchange of data using online forms.

There is a great risk that these data we have shared through the Internet are accessed by unauthorized users from cloud storage or they are intercepted by hackers during the transmission. There are also risks that the message or multimedia like: pictures or video clips that we share, post or stream are copied or recorded by other party and misused. There are many instances that the private, sensitive or objectionable picture or video clips that we share with our social media friends are captured or recorded and misused. So the rule of thumb, is not to share personal and objectionable data through social media or messaging apps. We will discuss different methods of stealing data in the Internet in the following section. Here, let's discuss some ways of securing data while storing or transferring them online.

We can protect our files with strong passwords so that the hacker cannot open it. A more reliable way is to use cryptography.

Cryptography is the study of secure communications techniques that allow only the

sender and intended recipient of a message to view its contents. The term is derived from the Greek word “ kryptos”, which means hidden. More generally, cryptography is about constructing and analysing protocols that prevent third parties or the public from reading private messages. Cryptography includes ensuring that data/ message cannot be understood by an unauthorized user. There are different types of cryptography technology used.

### i. Encryption

Encryption is the technology to encode file or message that is being stored or transferred online in intelligible content which cannot be used by an unauthorized person. The encryption is not meant to prevent interception but it makes the file or message unusable to the hacker. Authorized user can read or use the file or message after decrypting it. Generally, encryption is done with the help of key and the key is made available to the authorized user by another medium.

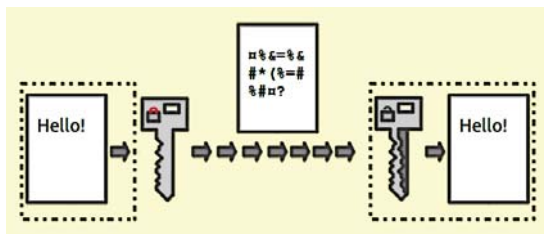

### ii. Decryption

The conversion of encrypted data into its original form is decryption. It is generally a reverse process of encryption. It decodes the encrypted information so that an authorized user can only decrypt the data because decryption requires a secret key or password.

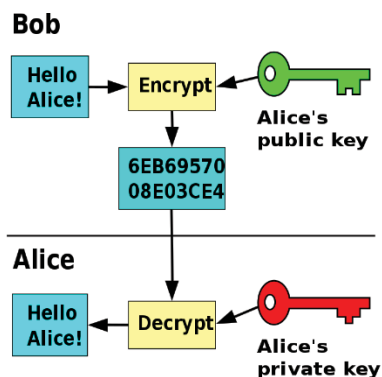

### iii. Malware

The word Malware is short for malicious software and is a general term used to describe all of the viruses, spyware, worms, adware, nagware, trojan, and pretty much anything that is specifically designed to cause harm to your PC or steal your information. Below, we discuss, in brief, about different types of Malware:

### a. Virus

A virus is a program that copies itself and infects a PC, spreading from one file to another, and then from one PC to another when the files are copied or shared. Most viruses attach themselves to executable files, but some can target



a master boot record, autorun scripts, MS Office macros, designed to render your PC completely inoperable, while others simply delete or corrupt your files—the general point is that a virus is designed to cause havoc and break stuff.

### b. Spyware

Spyware is any software installed on your PC that collects your information without your knowledge and sends that information back to the creator so they can use your personal information in some immoral way. This could include keylogging to learn your passwords, watching your searching habits.

### c. Trojan

Trojan horses are applications that look like they are doing something harmless, but secretly have malicious code that does something else. In many cases, Trojans will create a backdoor that allows your PC to be remotely controlled, either directly or as part of a botnet. The major difference between a virus and a Trojan is that Trojans don't replicate themselves—they must be installed by an unwitting user.

### d. Worm

Computer worms use the network to send copies of themselves to other PCs, usually utilizing a security hole to travel from one host to the next, often automatically without user intervention. Because they can spread so rapidly across a network, infecting every PC in their path, they tend to be the most well-known type of malware. Some of the most famous worms include the ILOVEYOU worm, transmitted as an email attachment.

### e. Adware

Adware is a software application used by companies for marketing purposes; advertising banners are displayed while any program is running. Adware can be automatically downloaded to your system while browsing any website and can be viewed through

pop-up windows or through a bar that appears on the computer screen automatically.

### 1.3.3 Antivirus Software

**Antivirus software**, nowadays also known as **anti-malware**, is a computer program used to prevent, detect, and remove **malware**.

When there were standalone computers, antivirus software was developed to detect and remove computer viruses. However, with the creation of other kinds of malware, antivirus software now provides protection from other computer threats. Today's antivirus software can protect from browser



hijackers, keyloggers, rootkits, Trojan horses, worms, adware, spyware, and many more. Some products also include protection from other computer threats, such as infected and malicious URLs, scam and phishing attacks. There are many antivirus software available in the market from simple Antivirus software to Internet Security System. The major consideration to be taken while choosing the antivirus software is its features. We have to see what threats it can protect our system from. Even the product of the same brand has different variations to provide different types of security. Some of the popular antivirus programs are Bitdefender Antivirus Plus 2020, Norton AntiVirus(NAV) Plus, Webroot SecureAnywhere AntiVirus, ESET NOD32 Antivirus, F-Secure Antivirus SAFE, Kaspersky Anti-Virus, etc.

There are many viruses and malware being developed every day. Old Antivirus program cannot detect and clean new virus or malware. So, we have to ensure that the Antivirus software we are using has the latest updates. Most of the Antivirus software now comes with an online update facility.

### 1.3.4 Backing System

You never know when or how data may be lost. A simple disk error can do just as much damage as a hacker might do. And even the most experienced computer user occasionally deletes a file or folder by accident. When such events happen, you'll be in trouble if

your data aren't backed up. Backup is the system of copying data and programs into another location or creating a duplicate copy of it's in a secured place. Backups are essential to computer security system to save important data and programs from the accidental or intentional harm. Any organization that does not maintain backups of data and information would need



to spend resources in recreating data if data is corrupted. When data and software are corrupted or lost, we can recover them from the backup copy. Backups can be kept in different locations such as hard disks, compact disc, external hard drive and on the cloud (Internet). So, Backups are important methods of data and software security measures against data corruption or loss.

### 1.3.5 Hardware Security

Computer is made of electronic boards, chips, electromagnetic devices like hard disk, electromechanical parts like CPU Fan, DVD-Drive motors etc. The hardware can be damaged by:

- dust dirt on mechanical parts;
- water and moisture on the electronic circuits;
- irregular electricity on the circuit boards;
- overheating of the device
- fire burning the machine
- theft of the computer and its devices
- So, to protect the computer hardware we can take the following measures;

#### i. Regular Maintenance

- Keep the computer room clean.
- Arrange regular maintenance of the computer system and devices. During the periodic maintenance dust and dirt



should clean off the computer's devices, loose connections of electricity and



network devices and parts inside the computers are should be fixed.

- Faulty devices are detected and replaced. We can do this by bringing our computers and devices to the service centre or by having Annual Maintenance Contract (AMC) with a service providing company depending on the policy of organization and number of computers and devices.

## **ii. Insurance**

Insurance is a way to get the investment – whole or part of it – back in case, the computer system is damaged because of theft, vandalism or natural calamities like fire or flood. For insurance of assets we have to contact the agent of a non-life insurance company and against the payment of a nominal amount of money as premium every year we can ensure our computer and other assets.

## **iii. Free from dust**

Often dust build-up occurs in computer case fans, inside the power supply or CPU cooler. When CPU cooler fails to spin because of dust build-up, processor can overheat and become damaged. If the power supply fan blows, this can become a serious fire hazard because of the heat being generated. These components need to be maintained for safety on a regular basis. So, the compute room has to be absolutely free from dust and air pollution.



## **iv. Fire extinguisher**

Install fire extinguishers in the computer room. So that in case of fire we can extinguish the fire quickly and minimize damage.



## **v. Theft**

The computer room should have physical security with proper locking system, controlled access of authorized persons only by having human guard or biometric machine.

## **vi. Air condition system**

When the computer system is used for a long time, it becomes heated. If the computer

system room contains servers and other devices that have to do extensive processing; then we should consider installing air conditioning system in the room. The air condition system helps to reduce the room temperature.



### **vii. Power protection device**

Have reliable electric system – cable, switches in the computer room, checking and replacing them regularly.

Use voltage stabilizers, spike controllers or Uninterruptible Power Supplies (UPS) to avoid irregular electric supplies like high voltage, fluctuating voltage or power cuts.



Frequent power cuts may not only cause damage to the computer hardware but also causes data loss that we are currently working. An UPS is a device which has a battery backup in it which is charged when there is power in the mains and automatically switches to the battery power when the mains gets cut off and thus helps to prevent the computer from being turned off at the time of power cut and save our data that we are working. It also protects accidental damage (file being corrupt) of program or data file.

## **Summary**

- Nowadays, we can copy important data into online storage devices which is also called cloud storage.
- Phishing is a fake attempt to obtain sensitive information.
- Keylogger is hardware or software for recording the keys pressed on a keyboard.
- A computer hacker is any skilled computer expert who uses technical knowledge to overcome a problem.
- Malicious code is the kind of harmful computer code or web script designed to create system vulnerabilities.
- The authentication system is the process of identifying an individual usually based on a username and password.
- A password is a memorized secret used to confirm the identity of a user.

- Biometric verification is uniquely identified by evaluating one or more distinguishing biological traits.
- A firewall is the network security systems that monitors and controls the traffic flow between the Internet and private network.
- Cryptography is the study of secure communications techniques that allow only the sender and intended recipient of a message to view its contents.
- The term is derived from the Greek word “ kryptos”, which means hidden.
- Encryption is the technology to encode file or message.
- The conversion of encrypted data into its original form is decryption.
- Malware is short for malicious software, and is a general term used to describe all of the viruses, spyware, worms, adware, trojan.
- Spyware is any software installed on your PC that collects your information without your knowledge
- Adware is a software application used by companies for marketing purposes
- Day by day new viruses developed which has different effects and symptoms.
- Computer viruses can spread through many different source or media.
- The computer virus is a small destructive program whose intention is harmed computer software and data.
- Some viruses produce unnecessary messages on the screen, some virus hide files, some virus corrupt files and programs, some virus reduce memory size, etc.
- Computer viruses can spread from one computer to other computers through many different media or sources.
- To make computer system free from viruses, antivirus software is used.
- Antivirus software is a type of program designed to detect and remove viruses from computer system.
- Insurance is a way to get the investment whole or part of it back in case the computer system is damaged
- The computer room should have physical security with proper locking system.
- Use voltage stabilizers, spike controllers or Uninterruptible Power Supplies (UPS)

to avoid irregular electric supplies.

- Frequent power cuts not only may cause damage to the computer hardware but also causes data loss.

## Exercises

### 1. Answer the following questions.

- What is computer security?
- Define hardware security.
- What is data and information security?
- List some points about how we can protect our data.
- What is a backup? Why is backup vital to computer security system?
- Write down any six possible threats to computer security.
- What is the password? Why is password used in a computer?
- Define Encryption and Decryption.
- What are the security threats? Explain any two in brief.
- What are malicious codes?
- Define antivirus software with four examples.
- Define Firewall with examples.
- What is biometric verification?
- Write down any four preventive measures of computer hardware security.
- Point out any four computer software security measures.
- What is software security? Write any four measures of hardware security.
- What is a power protection device? Write its role in computer security.
- Why is it important to protect computer system from dust?

### 2. Write the full form of.

- |        |          |           |          |        |
|--------|----------|-----------|----------|--------|
| i) CD  | ii) DVD  | iii) IoT  | iv) HTTP | v) PIN |
| vi) PC | vii) NAV | viii) AMC | ix) CPU  | x) UPS |

**3. Give appropriate technical terms of the followings.**

- a) The fake attempt to obtain sensitive information
- b) The hardware or software for recording the keys pressed on a keyboard
- c) Law that governs the legal issues of cyberspace
- d) The skilled computer expert who uses technical knowledge to overcome a problem
- e) The kind of harmful computer code or web script designed to create system vulnerabilities
- f) The process of identifying an individual usually based on a username and password
- g) A memorized secret used to confirm the identity of a user
- h) A process of performing variety of tech-enabled activities via virtual communities and network
- i) The uniquely identified by evaluating one or more distinguishing biological traits
- j) The network security systems that monitors and controls the traffic flow
- k) The technology to encode file or message
- l) A small destructive program whose intention is harms computer software and data

**4. Tick (✓) the correct answer.**

- 1. The term computer security refers to
  - i. Use of antivirus
  - ii. Protection of software
  - iii. Protection to a computer system
  - iv. Use of firewall
- 2. .... is the measurement of things such as fingerprints and retinal scans used for security access.
  - i. Biometrics
  - ii. Bio measurement
  - iii. Computer security
  - iv. Smart weapon machinery
- 3. To prevent the loss of data during power failures, use a(n): .....

- i. encryption program
- ii. surge protector
- iii. firewall
- iv. UPS
- d. The system can be damaged by .....
- i. Faulty wiring
- ii. Bad command
- iii. Illegal password
- iv. Antivirus software

**5. State whether the statements are 'True' or 'False'.**

- a) A threat is anything that can cause harm.
- b) Power protection devices protect computer software.
- c) Insurance is one of the computer security measures.
- d) UPS is a device that maintains a constant voltage level.
- e) Air conditioning unit is a device that monitors and maintains the temperature.
- f) We can use a backup copy of our data to restore lost files to our PC.
- g) Password policy is very important for software security.
- h) The greatest threat to software is a computer virus.
- i) A firewall's main purpose is to prohibit unauthorized access to our computer via the Internet.

## **Project Work**

---

1. Prepare a presentation on the topic "Some Measures to Protect from Threats" and present in your class.
2. Explain "Security mechanisms" in a sheet of chart paper with figures.
3. Prepare a presentation file on a topic "Different types of Malware" and present in your class.



- g) Information sharing and distribution Protocol
- h) And different Web services

### Traditional Commerce vs. E-Commerce

As we know, E-commerce is completely worked in a digital and an online mode whereas traditional commerce is done offline and through in person or face to face.

### Similarities

- a) Both want to make profit.
- b) Both aim to deliver a high-quality product or service.
- c) Both want to serve a large number of customer.
- d) Both try to quickly deliver products and services.

### Differences

- a) E-commerce customers expect shorter fulfilment time.
- b) E-commerce customers must understand web-based technologies.
- c) E-commerce provides a global audience.
- d) Orders in E-commerce are processed without human interaction or travel to a store location.

### E-Commerce practices in Nepal



Now in Nepal too, you can sell and buy any type of goods and services such as mobile phones, laptop, air ticket, pay electricity bill through online services. There are many popular Nepali online shopping sites such as daraz.com.np, nepbay.com, BhatBhatenionline.com, Metrotarkari.com, kinmel.com.np, hamrobazaar.com, muncha.com and many more. You can buy online and pay through different local payment



gateway like e-Sewa, Khalti or cash on delivery mode.

### **Below are some of the E-commerce trends in Nepal**

- a) Practice of sending gifts
- b) Trending free classifieds and online market web portals
- c) Showcasing over internet/online shopping
- d) Get latest Products from International Shopping portals
- e) Social Media Selling Platforms

### **Benefits and Limitations of E-Commerce**

E-Commerce and its associated technology have brought many changes in our daily lives. We don't need to spend the whole day to pay an electricity bill. Now, we can do this just within a minute. We don't need to bargain in shops. We can compare the prices in different e-commerce sites and choose the best one.

#### **Advantages of E-Commerce**

- a) Faster buying/selling procedure, as well as easy to find products.
- b) Buying/selling anytime and anywhere
- c) As there are no geographical limitations, can deliver service globally
- d) Does not required physical stores
- e) Low operational costs and better quality of services
- f) No need of physical company set-ups.
- g) Easy to start and manage a business. One can sell online through social media as well.
- h) Customers can review the comments and compare in different sites without moving around physically.

#### **Limitations of E-Commerce**

Though E-Commerce has many benefits, it also has some limitations which are listed below:

- a) Lack of personal touch. We cannot touch the goods physically

- b) We cannot do any transaction without Internet access device. So, it is heavily dependent on Internet technologies
- c) Not all goods can be purchased online
- d) Easy to set up so anyone can start e-commerce site. We need to be careful about the quality of product and service delivery
- e) Security issues of customer's information
- f) Not everyone is connected to the Internet so we cannot accommodate all the people
- g) Technical failures can cause unpredictable effects on the total processes

## Types of E-Commerce

E-commerce can be run in different models. Here, we discuss the three basic types of E-Commerce

### a) Business-to-Consumer (B2C)

The most common type of E-Commerce is Business-to-Consumer. B2C establishes the electronic business relationships between a business organization (merchant) and final consumers. It corresponds to the retail section of e-commerce, where traditional retail trade normally operates.



In B2C model, business E-Commerce website is the main platform where all the business transactions take place between a business organization and consumer directly. Amazon.com is a good example of B2C e-commerce.

## b) Business-to-Business (B2B)

Business-to-Business (B2B) e-commerce is conducted between companies. Individual customer cannot buy from this type of e-commerce. Producers and wholesalers typically operate with this type of electronic commerce.

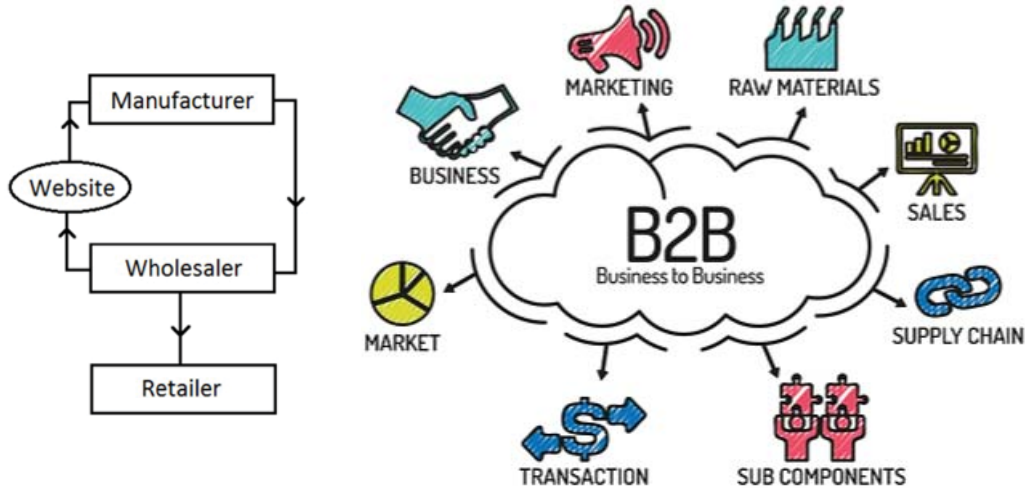

In this model, the product is first sold to wholesaler who then sells the product to the final customer. As an example, a wholesaler places an order from a company's website and after receiving the consignment, sells the end product to final customer who comes to buy the product at wholesaler's retail outlet. Alibaba.com is a good example of B2B e-commerce.

## c) Consumer-to-Consumer (C2C)

Consumer-to-Consumer (C2C) type of e-commerce is conducted between consumers. Generally, these transactions are conducted through a third party, which provides the online platform where the transactions are actually carried out. Hamrobazaar.com is a good example of C2C website in Nepal.

Website following C2C business model helps consumer to sell their assets like residential property, cars, motorcycles etc. or rent a room by publishing their information on the website. Website may or may not charge the consumer for its services. Another consumer may opt to buy the product of the first customer by viewing the post/advertisement on the website.

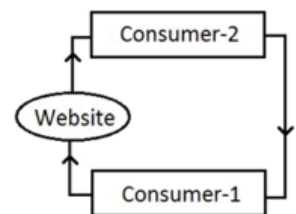

## M-Commerce

M-commerce (Mobile commerce) is the extended version of e-commerce. It refers to the process of buying and selling of goods and services through wireless handheld devices such as smartphones, tablets or personal digital assistants (PDAs). It is also known as next-generation e-commerce.

This includes purchases on websites or apps, paying for travel, hotel, events or bills or any type of commerce that is conducted using a mobile device.

### Typical examples of M-commerce are

- a) Purchasing airline tickets
- b) Purchasing movie tickets
- c) Restaurant/Hotel booking and reservation
- d) Top-Up Charges
- e) Balance Enquiry
- f) Utility Payment
- g) Fund Transfer

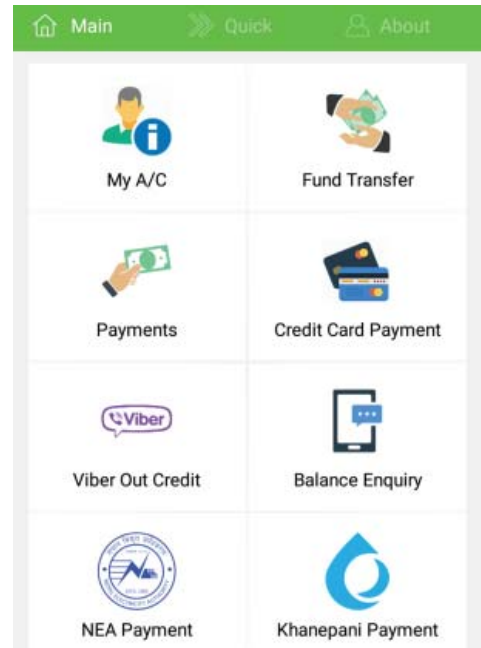

### Online Payment

After purchasing something from buyer, we need to pay money. Online payment or E-payment is one of the major components of an e-commerce transaction. It refers to the payment for buying goods or services through the Internet using different online payment gateway.



## **Different modes of Electronic Payments**

- a) Credit Card
- b) Debit Card
- c) Smart Card
- d) E-Money
- e) Electronic Fund Transfer (EFT)
- f) E-Cheque

## **Likewise, different forms of e-payment in Nepal include**

- a) Credit Cards (introduced by Nabil Bank in 1990)
- b) Debit Cards (all commercial banks)
- c) Automated teller machines (introduced by Himalayan Bank Ltd. in 1995)
- d) Electronic fund transfers at points of sale (EFTPOS)
- e) Internet banking (introduced by Kumari Bank Ltd. in 2002)
- f) Mobile banking; (introduced by Laxmi Bank Ltd. in 2004).
- g) Digital Wallet such as e-sewa, Khalti etc.
- h) Cash on Delivery (CoD) – if you don't have any online payment system then you can pay cash when you receive the product from delivery person.

## **Summary**

---

- E-Commerce refers to the buying and selling of goods and products over computer communication network such as the Internet.
- Technology used in E-Commerce includes E-mail, Fax, Online catalogues and shopping carts, EDI, Online Payment Gateway, Security tools, network protocol and different web services.
- The three basic types of E-Commerce models are Business-to-Consumer (B2C), Business-to-Business (B2B) and Consumer-to-Consumer (C2C).
- Business-to-Consumer is conducted between merchant companies and individual consumers. This is the most common e-commerce type.
- Business-to-Business (B2B) e-commerce is conducted between companies. Individual customer cannot buy from this type of e-commerce.

- Consumer-to-Consumer (C2C) e-commerce platform provides opportunities for individual consumers to buy or sell goods or services online.
- M-Commerce refers to the process of buying and selling of goods and services through smartphones, tablets or personal digital assistants (PDAs).
- Online payment refers to the payment for buying goods or services through the Internet using different online payment gateway.

## Tecchnical Terms

E-Commerce	: Buying and Selling online
M-Commerce	: Commercial transaction through mobile devices
Online Payment	: Paperless payment through Internet
B2C E-Commerce	: Online purchases between a business and a consumer
B2B E-Commerce	: Online purchases between business
C2C E-Commerce	: Online purchases between consumers

## Exercises

### 1. Answer the following questions.

- Define E-Commerce.
- What is the business done through the internet?
- Mention the benefits and limitations of E-Commerce.
- Explain the different types of E-Commerce.
- What is M-Commerce? Give some examples.
- What is Online Payment? Write the different forms of e-payment in Nepal.

### 2. Write 'True' for the correct and 'False' for the incorrect statement.

- Alibaba.com is an example of C2C e-commerce.
- Cash on Delivery is one of the options of online payment.
- There are basically four types of e-commerce model.
- E-commerce is driven by internet technology.
- E-commerce provides a global audience.

- f) Sometimes, e-commerce can be conducted offline if there is no Internet facility.
- g) It is very difficult to set up an e-commerce site.
- h) Individual customer can purchase in B2B e-commerce.
- i) Credit Card is an example of online payment.

**3. Write the full form of.**

- a) EDI          b) B2C          c) B2B          d) C2C          e) M-Commerce
- f) PDA          g) EFT          h) CoD          i) EFTPOS

**4. Write short notes on.**

- i) Online Payment
- ii) Traditional Commerce vs. E-Commerce

## Activities

---

1. Prepare a presentation file on the topic “Current trends of E-Commerce in Nepal” and present in your class as group work.
2. Collect the names, logo and other related information of different Nepalese e-commerce Website and demonstrate in a sheet of chart paper.
3. Explore the below e-commerce sites and browse the different parts and prepare a small report.
  - a) Amazon.com
  - b) Ebay.com
  - c) Flipcart.com
  - d) Snapdeal.com
  - e) daraz.com.np
  - f) sastodeal.com
  - g) hamrobazaar.com
  - h) expedia.com
  - i) esewa.com.np

# Contemporary Technology

## Introduction

These days technology has become a part of our life. We can't imagine a life without Internet and Smartphones in urban areas and even in rural environments. Most of the services like Email, Social Network, E-Commerce, Chats, on-demand videos, live streaming etc. are becoming omnipresent and helping human beings to get connected with each other and get their work done efficiently and effectively. Behind all these services, there are many integrated technologies working together like Cloud Computing, Artificial Intelligence, Virtual Reality, IoT, etc.

### 1.5.1 Cloud Computing

Due to increased number of users, and increased complexity of software systems, demand for hardware resources like processors, memory, storage, network, database, software and other services has also been increased. In order to address this demand, companies like Amazon, Microsoft, Google, etc. are providing very large server farms and data centres over the Internet to multiple

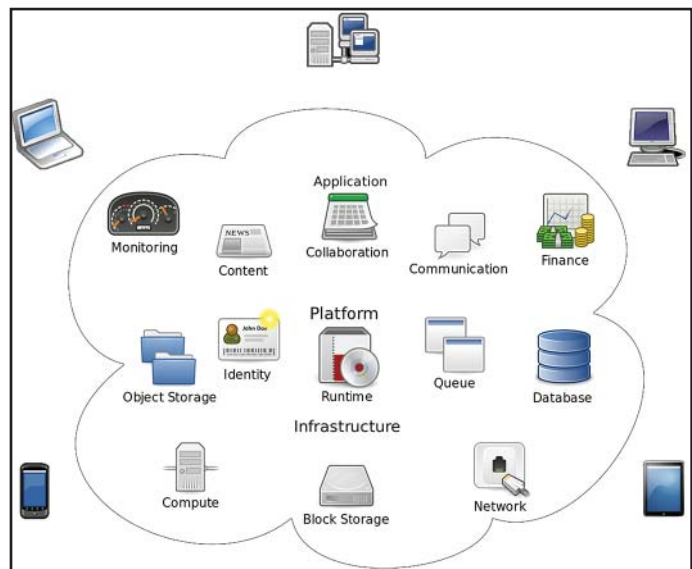

customers, who pay only for the resources they use. Because organizations using public clouds do not own the infrastructure, they don't have to make large investment in their own hardware and software. Public clouds are ideal for small and medium-sized businesses who can't afford to fully develop their own infrastructure; for applications requiring high performance, scalability, and availability. Such model of computing in which processing, storage, software and other services are provided as a shared pool



of virtualized resources is called cloud computing.

Companies offering these computing services are called cloud providers and typically charge for cloud computing services based on usage, similar to how we paid the bill for water, electricity, telephone at home. Some of the cloud providers are Amazon AWS, Microsoft Azure, Google Cloud, IBM Cloud, VMware Cloud, Oracle Cloud and Alibaba Cloud.

You are probably using cloud computing right now, even if you don't realise it. If you use an online service to send an email, edit documents, watch movies or TV, listen to music, play games or store pictures and other files, it is likely that cloud computing is making it all possible behind the scenes.

### **Here are a few of the things you can do with the cloud**

- Create new apps and services,
- Store, back up and recover data,
- Host websites and blogs,
- Stream audio and video,
- Deliver software on demand.

### **Examples of Services over Cloud**

**Microsoft Office 365:** Internet versions of Word, Excel, PowerPoint, and OneNote accessed via your Web browser without installing anything.



**Google Drive:** This is a pure cloud computing service, with all the storage found online. So it can work with the **cloud apps** like: **Google Docs, Google Sheets, and Google Slides.** Google Drive is also available on more than just desktop computers; you can use it on tablets like the iPad or on smartphones, and there are separate apps for Docs and Sheets, as well. In fact, most of Google's services could be considered cloud computing; Gmail, Google Calendar, Google Maps, and so on.



**Apple iCloud:** Apple's cloud service is primarily used for online storage, backup, and synchronization of your mail, contacts, calendar, and more.



### **There are three basic types of cloud computing services**

- 1. Infrastructure as a Service (IaaS):** In this type of cloud service, customer can use processing, storage, networking, and other computing resources from cloud service providers to run their software system. Customers are billed according to the usages of computing power and storage.
- 2. Software as a Service (SaaS):** Customer subscribes the software services from a vendor for an annual subscription fee or sometimes free and use it over Internet. Services like Gmail, Google Drive, Salesfore.com - very popular Customer Relationship Management Software (CRM), Office 365 are some of the examples of SaaS.
- 3. Platform as a Service (PaaS):** Customer use infrastructure and programming tools and environment supported by the vendors to develop their own applications. IBM provides Bluemix for software development and testing on its cloud.

### **1.5.2 Artificial Intelligence (AI)**

In the past, a piece of software is written to do a well-defined task. If the same software has to do another similar task then it has to be re-written. Nowadays, due to advanced mathematical algorithms and high computations power of hardware, software can be designed to learn and adapt the results



based on the data fed into it. This means, such software can work similar to human intelligence, such software can identify objects, animals, places, detect face, and talk like humans do. They can also suggest and recommend like human experts in respective field. Artificial Intelligence is the study and research of developing such software that can learn and, work like human brain.

In other words, Artificial intelligence (AI) refers to systems or machines that mimic

human intelligence to perform tasks and can iteratively improve themselves based on the information they collect.

AI technology is improving performance and productivity by automating processes or tasks that once required human intelligence.

Some of the examples of AI are speech recognition (like Siri, Microsoft Cortana, Amazon Echo, Google Home etc.), spam email filter, self-driving cars, face recognition etc.

### 1.5.3 Virtual Reality (VR)

In virtual reality, you experience a simulated environment that doesn't actually exist, created through computer-based technologies that can give you a feel of near real world with all or some of your senses experiencing the virtually simulated environment. You can also interact with virtual objects within the virtual environment. You can swim with whales in oceans, fight with aliens, fly aeroplanes, visit distance places without being there and much more within the VR.



These days, you can find various types of head-mounted display to experience virtual reality. You can also experience virtual reality in specialized cinema halls as well.

### 1.5.4 E-Governance

E-Governance is a set of services provided by the government to public via electronic media especially using Internet. Examples of such services include paying their taxes online, requesting various services from government through governmental websites, providing information to public via government's websites. The basic purpose of e-governance is to simplify processes for all, i.e. government, citizens,



businesses, etc. at National, State and local levels. E-governance expands to electronic governance, is the integration of Information and Communication Technology (ICT) in all the processes, with the aim of enhancing government ability to address the needs of the general public.

### **Benefits of E-governance**

- Increased convenience for public and businesses to services of government
- Reduction in overall cost of transaction as services can be rendered anywhere
- Corruption will be reduced as there will be direct interaction with the system and public without any intermediaries
- High transparency
- Direct participation of constituents
- Expanded reach of government to all public irrespective of remoteness

Through e-governance, the government plans to raise the coverage and quality of information and services provided to the general public, by the use of ICT in an easy, economical and effective manner.

### **1.5.5 Mobile Computing**

Mobile devices like smartphones, tablets, e-readers, wearable devices that have computing power, battery-powered, portable, and wirelessly connected to network have changed the way, we used to access the computing resources in the past. Due to advancement in technologies, such mobile devices have integrated various features like cameras, biometrics, sensors etc. Mobile computing is a generic term that refers to a variety of devices that allow people to access data and information from wherever they are. Sometimes referred to as "human-computer interaction," mobile computing transports data, voice, and video over a network via a mobile device.

### **Components of Mobile Computing**

- i. **Mobile Hardware:** Mobile hardware are generally small in size and highly portable with the ability to process data and give output based on inputs given by keypad, touch, voices or sensors. These devices are equipped with sensors, full-duplex data transmission and have the ability to operate on wireless networks

such as IR, Wi-Fi, Cellular and Bluetooth.

- ii. **Mobile Software:** Mobile Software is the software program which is developed specifically to be run on mobile hardware. This is usually the operating system in mobile devices. These operating systems provide features such as touchscreen, cellular connectivity, Bluetooth, Wi-Fi, GPS mobile navigation, camera, video camera, speech recognition, voice recorder, music player, near field communication and sensors. The device sensors and other hardware components can be accessed via the OS.



- iii. **Mobile Communication:** Mobile Communication refers to the exchange of data and voice using existing wireless networks. The data being transferred are the applications including File Transfer (FT), the interconnection between Wide-Area-Networks (WAN), facsimile (fax), electronic mail, access to the Internet and the World Wide Web. The wireless networks utilized in communication are IR, Bluetooth, W-LANs, Cellular, W-Packet Data networks and satellite communication system. It is the mobile communication infrastructure which takes care of seamless and reliable communication between mobile devices.

## Principles of Mobile Computing

The following factors have been identified as the Principles of Mobile Computing.

- i. **Portability:** Devices/nodes connected within the mobile computing system should facilitate mobility. These devices may have limited device capabilities and limited power supply but should have a sufficient processing capability and physical portability to operate in a movable environment.
- ii. **Connectivity:** This defines the quality of service of the network connectivity. In a mobile computing system, the network availability is expected to be maintained at a high level with the minimal amount of lag downtime without being affected

by the mobility of the connected nodes.

- iii. **Interactivity:** The nodes belonging to a mobile computing system are connected with one another to communicate and collaborate through active transactions of data.
- iv. **Individuality:** A portable device or a mobile node connected to a mobile network often denotes an individual; a mobile computing system should be able to adopt the technology to cater the individual needs and also to obtain contextual information of each node.

### 1.5.6 Internet of Things (IoT)

Few years earlier only computers and servers were able to communicate with each other by sharing data and information. Due to advancement in technology, computer-like device can be integrated with any electronic devices enabling these devices to share and communicate data to intended users and systems. Devices that can sense or read the values of their surrounding environment are more likely to have application for sharing/communicating information. Such devices



when connected with server to communicate data from their surrounding are called Internet of Things (IoT). In a simple way, you have things (devices) that can collect data and are capable to send these data via Internet to Server or any intended users. For example, a car with a GPS sensor (thing) continuously transmits its location information to any user via Internet. A temperature sensor (thing) that is reading temperature of a particular location and transmitting that data via Internet to a Web Server so that anyone from the world can know the temperature of that location/place.

Over the past few years, IoT has become one of the most important technologies of the 21st century. Now that we can connect everyday objects—kitchen appliances, cars, thermostats, baby monitors—to the Internet via embedded devices, seamless

communication is possible between people, processes, and things.

By means of low-cost computing, the cloud, big data, analytics, and mobile technologies, physical things can share and collect data with minimal human intervention. In this hyper connected world, digital systems can record, monitor, and adjust each interaction between connected things. The physical world meets the digital world—and they cooperate.

## Summary

---

- Cloud Computing is a type of Internet-based computing.
- Cloud Computing provides online resources (software, platform, infrastructure) on demand basis.
- Google Drive is an example of cloud storage.
- AI is an emerging branch in computer science, which interprets the means and method of making computers think like human beings.
- Siri on the iPhone and Microsoft's Cortana on Windows 8 and Windows 10 are the examples of AI.
- Amazon, Microsoft, Google, etc. are providing very large server farms and data centres over the Internet to multiple customers.
- Public clouds are ideal for small and medium-sized businesses who can't afford to fully develop their own infrastructure.
- Some of the cloud providers are Amazon AWS, Microsoft Azure, iCloud, Google Cloud, IBM Cloud, VMware Cloud, Oracle Cloud and Alibaba Cloud.
- There are three basic types of cloud computing services.
- Virtual Reality (VR) is the use of computer technology to create a simulated environment.
- E-Governance is a set of services provided by the government to public via electronic media especially using Internet.
- Mobile computing is a generic term that refers to a variety of devices that allow people to access data and information from wherever they are.
- Office Online is a completely free, web-based version of Microsoft Office.

- Google Drive is a file storage and synchronization service developed by Google.
- Apple iCloud is a cloud computing solution by Apple Computer Inc. that provides cloud storage and apps for desktop and mobile devices.
- IoT has become one of the most important technologies of the 21st century.
- IoT is a system of interrelated computing device to exchange information over a network without human-to-human or human to computer interaction.

## Exercises

### 1. Answer the following questions.

- a) What is the most futuristic technology?
- b) What are the advantages of cloud computing?
- c) What are the types of cloud computing services?
- d) List some areas where AI can help us and how?
- e) How is AI software different from other software?
- f) How can public get benefited from the e-governance services?
- g) Provide some example of e-governance services that exist in Nepal?
- h) What is IoT? Write any two importance of it.
- i) Give some examples of IoT devices and their applications?
- j) How do you think, IoT devices can help in our day to day life?

### 2. Fill in the blanks.

- a) .....clouds are ideal for small and medium-sized businesses.
- b) ..... is a pure cloud computing service, with all the storage found online.
- c) Customers are billed according to the usages of computing power and .....
- d) ..... refers to systems or machines that mimic human intelligence to perform tasks.
- e) The various types of ..... display to experience virtual reality.



- f) Mobile communication refers to the exchange of data and .....
- g) ..... is the software program which is developed specifically to be run on mobile hardware.

**3. Give the full forms of the following.**

- i) e-Com      ii) IaaS      iii) SaaS      iv) PasS      v) AI
- vi) VR      vii) ICT      viii) E-Gov      ix) WiFi      x) GPS
- xi) W-LAN      xii) QoS      xiii) IoT

**Project Work**

---

1. Prepare a presentation file on the topic “Examples of Services over Cloud” and present in your class.
2. Explain three “Basic types of cloud computing services ” in a sheet of chart paper with figures.
3. Prepare a presentation file on the topic “Sophia Robot in Nepal” and present in your class.
4. Prepare a presentation file on the topic “Internet of Things (IoT) with example” and demonstrate in your class
5. Prepare a presentation file on the topic “E-Governance” and present in your class.

# Number System

Many years ago, the concept of number system evolved when people used their fingers, sticks, pebbles, knots of rope and different symbols for counting and simple addition or subtraction. In course of time, people use calculator device and then computers for calculation. The group of digits or symbols used to express quantities as the basis for doing different calculations is called number system.

## Types of Number System

Nowadays, different types of number system have developed. Number system is differentiated by its base or radix. The base is defined as the total number of digits available in the number system. So, the number system is divided into main four types on the basis of base value. They are:

1. Decimal number system,
2. Binary number system,
3. Octal number system and
4. Hexadecimal number system.

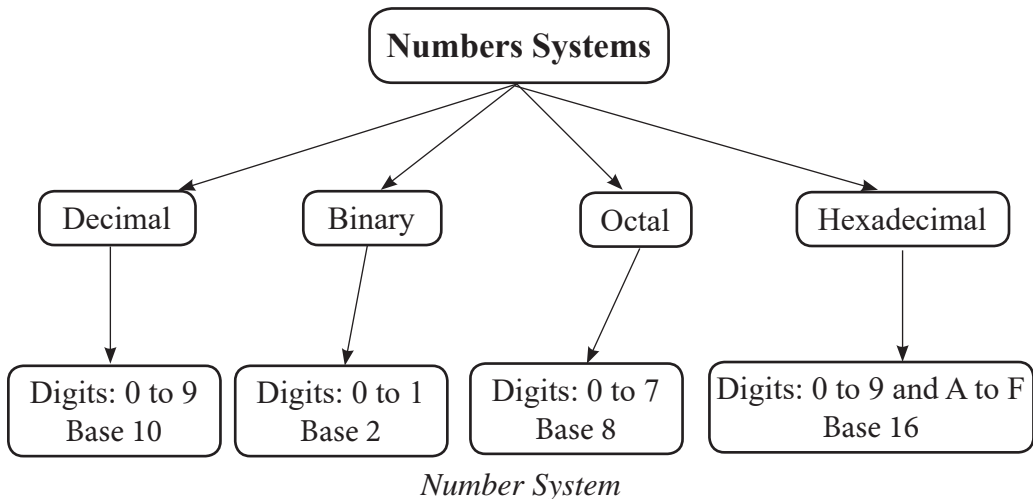

### 1. Decimal Number System

The number system that we use in our day to day life is the decimal number system.

Decimal number system has base 10 as it uses 10 digits from 0 to 9. In decimal number system, the successive positions to the left of the decimal point represent units, tens, hundreds, thousands, and so on.

Each position represents a specific power of the base (10). For example, the decimal number 539 consists of the digit 9 in the units position, 3 in the tens position and 5 in the hundreds position. Its value can be written as

$$\begin{aligned}(539)_{10} &= (5 \times 100) + (3 \times 10) + (9 \times 1) \\ &= (5 \times 10^2) + (3 \times 10^1) + (9 \times 10^0) \\ &= 500 + 30 + 9 \\ &= 539\end{aligned}$$

## 2. Binary Number System

The number system that is used in computer system to hold any data on bits is the binary number system. Binary number system has base 2 as it uses 2 digits 0 and 1. For example 100012 , 111012 , 1012 , etc.

## 3. Octal Number System

The number system that is used in computer system to hold any data on byte is the octal number system. Octal number system has base 8 as it uses 8 digits from 0 to 7. For example 1208 , 65708 , 320708 , etc.

## 4. Hexadecimal Number System

The number system that is used in computer system to hold any data is the hexadecimal number system. Hexadecimal number system has base 16 as it uses 16 digits (10 digits from 0 to 9 and 6 letters from A to F). Letters represent the numbers starting from 10 that is A = 10, B = 11, C = 12, D = 13, E = 14 and F = 15. For example  $(7A2)_{16}$ ,  $(1AC)_{16}$ ,  $(56B)_{16}$ ,  $(BOD)_{16}$  etc.

## Number System Conversion

People commonly use decimal number system in their daily life. Computer use binary, octal and hexadecimal number system according to its model or brand. We cannot easily

understand binary number system like this way computer can't understand decimal number system. So there are different methods to convert one number system to another as follows:

### 1. Decimal to Binary Number System Conversion

To convert decimal number to binary number follows the following steps:

- Divide the given decimal number by 2 and write down the remainder.
- Divide quotient by 2 and again write down the remainder.
- Repeat the process until quotient becomes zero.
- Write the remainders from bottom to top.

#### Examples:

i.  $(46)_{10} = (?)_2$

2	46	Remainder
2	23	0
2	11	1
2	5	1
2	2	1
2	1	0
	0	1

$$(46)_{10} = (101110)_2$$

ii.  $(25)_{10} = (?)_2$

2	25	Remainder
2	12	1
2	6	0
2	3	0
2	1	1
2	0	1

$$(25)_{10} = (11001)_2$$

## 2. Binary to Decimal Number System Conversion

To convert binary number to decimal number follows the following steps:

- Multiply each binary digit with its place value ( positive powers of two that is 2<sup>0</sup>, 2<sup>1</sup>, 2<sup>2</sup>, 2<sup>3</sup>, 2<sup>4</sup> .....)
- Add all the products calculated in step 1 and total number is decimal equivalent number.

### Examples:

i.  $(10011)_2 = (?)_{10}$

$$\begin{aligned}(10011)_2 &= 1 \times 2^4 + 0 \times 2^3 + 0 \times 2^2 + 1 \times 2^1 + 1 \times 2^0 \\ &= 1 \times 16 + 0 \times 8 + 0 \times 4 + 1 \times 2 + 1 \times 1 \\ &= 16 + 0 + 0 + 2 + 1 \\ &= 19\end{aligned}$$

ii.  $(110101)_2 = (?)_{10}$

$$\begin{aligned}(110101)_2 &= 1 \times 2^5 + 1 \times 2^4 + 0 \times 2^3 + 1 \times 2^2 + 0 \times 2^1 + 1 \times 2^0 \\ &= 1 \times 32 + 1 \times 16 + 0 \times 8 + 1 \times 4 + 0 \times 2 + 1 \times 1 \\ &= 32 + 16 + 0 + 4 + 0 + 1 \\ &= 53\end{aligned}$$

## 3. Decimal to Octal number system conversion

To convert decimal number to octal number follows the following steps:

- Divide the given decimal number by 8 and write down the remainder.
- Divide quotient by 8 and write down the remainder.
- Repeat the process until quotient becomes zero.
- Write the remainders from bottom to top.

### Examples:

i.  $(345)_{10} = (?)_8$

8	345	Remainder
8	43	1
8	5	3
	0	5

$$(345)_{10} = (531)_8$$

ii.  $(905)_{10} = (?)_8$

8	905	Remainder
8	113	1
8	14	1
8	1	6
	0	1

$$(905)_{10} = (1611)_8$$

## 4. Octal to Decimal Number System Conversion

To convert octal number to decimal number follows the following steps:

- Multiply each octal digit with its place value ( positive powers of two that is 80, 81, 82, 83, 84.....)
- Add all the products calculated in step 1 and total number is decimal equivalent number.

### Examples:

i.  $(157)_8 = (?)_{10}$

$$(157)_8 = 1 \times 8^2 + 5 \times 8^1 + 7 \times 8^0$$

$$= 1 \times 64 + 5 \times 8 + 7 \times 1$$

$$= 64 + 40 + 7$$

$$= 111$$

ii.  $(702)_8 = (?)_{10}$

$$\begin{aligned} (702)_8 &= 7 \times 8^2 + 0 \times 8^1 + 2 \times 8^0 \\ &= 7 \times 64 + 0 \times 8 + 2 \times 1 \\ &= 448 + 0 + 2 \\ &= 450 \end{aligned}$$

## 5. Decimal to Hexadecimal Number System Conversion

To convert decimal number to hexadecimal number follows the following steps:

- Divide the given decimal number by 16 and write down the remainder.
- Divide quotient by 16 and write down the remainder.
- Repeat the process until quotient becomes zero.
- Write the remainders from bottom to top.

### Examples:

i.  $(88)_{10} = (?)_{16}$

16	88	Remainder
16	5	8     ↑
	0	5

$$(88)_{10} = (58)_{16}$$

ii.  $(923)_{10} = (?)_{16}$

16	923	Remainder
16	57	11(B)     ↑
16	3	9
	0	3

$$(923)_{10} = (39B)_{16}$$

## 6. Hexadecimal to Decimal Number System Conversion

To convert hexadecimal number to decimal number follows the following steps:

- Multiply each octal digit with its place value ( positive powers of two that is 160, 161, 162, 163, 164 .....)
- Add all the products calculated in step 1 and total number is decimal equivalent number.

### Examples:

i.  $(1AC)_{16} = (?)_{10}$

$$\begin{aligned}(1AC)_{16} &= 1 \times 16^2 + 10 \times 16^1 + 1^2 \times 16^0 \\ &= 1 \times 256 + 10 \times 16 + 12 \times 1 \\ &= 256 + 160 + 12 \\ &= 428\end{aligned}$$

ii.  $(B0)_{16} = (?)_{10}$

$$\begin{aligned}(B0)_{16} &= 11 \times 16^1 + 0 \times 16^0 \\ &= 11 \times 16 + 0 \times 1 \\ &= 176 + 0 \\ &= 176\end{aligned}$$

Note:





Decimal	Hexadecimal	Octal	Binary
0	0	0	0
1	1	1	1
2	2	2	10
3	3	3	11
4	4	4	100
5	5	5	101
6	6	6	110
7	7	7	111
8	8	10	1000
9	9	11	1001
10	A	12	1010
11	B	13	1011
12	C	14	1100
13	D	15	1101
14	E	16	1110
15	F	17	1111

*Binary Table*

## 7. Binary to Octal Number System Conversion

To convert binary number to octal number follows the following steps:

- a. Arrange binary digits in group of three from right to left.
- b. Write respective octal number for each binary group.
- c. Give the result base 8.

### Examples:

i.  $(110010011)_2 = (?)_8$

3 digits combination = 110      010      011

Octal Equivalent = 6      2      3

$(110010011)_2 = (623)_8$

### Rough

4 2 1      4 2 1      4 2 1

1 1 0      0 1 0      0 1 1

4 + 2      2      2 + 1

6      2      3

ii.  $(100010011000)_2 = (?)_8$

3 digits combination = 100      010      011      000

Octal Equivalent = 4      2      3      0

$(100010011000)_2 = (4230)_8$

### Rough

4 2 1      4 2 1      4 2 1      4 2 1

1 0 0      0 1 0      0 1 1      0 0 0

4      2      2+1      0

4      2      3      0

## 8. Octal to Binary Number System Conversion

To convert octal number to binary number follows the following steps:

- Write binary triple equivalent to each octal number.
- Give the result base 2.

### Examples:

i.  $(236)_8 = (?)_2$

Octal number            =    2            3            6

Binary equivalent    =    010            011            110

$$(236)_8 = (010011110)_2$$

### Rough

2	3	6
4 2 1	4 2 1	4 2 1
0 1 0	0 1 1	1 1 0

ii.  $(704)_8 = (?)_2$

Octal number            =    7            0            4

Binary equivalent    =    111            000            100

$$(704)_8 = (111000100)_2$$

### Rough

2	3	6
7	0	4
4 2 1	4 2 1	4 2 1
1 1 1	0 0 0	1 0 0

## 9. Binary to Hexadecimal number system conversion

To convert binary number to hexadecimal number follows the following steps:

- Arrange binary digits in group of four from right to left.
- Write respective hexadecimal number for each binary group.
- Give the result base 16.

### Examples:

i.  $(110010011)_2 = (?)_{16}$

4 digits combination = 0001      1001      0011

Hexadecimal equivalent = 1      9      3

$$(110010011)_2 = (193)_{16}$$

#### Rough

8 4 2 1      8 4 2 1      8 4 2 1

0 0 0 1      1 0 0 1      0 0 1 1

1      8+1      2+1

1      9      3

ii.  $(10001001100)_2 = (?)_{16}$

4 digits combination = 0100      0100      1100

Hexadecimal equivalent = 4      4      C

$$(10001001100)_2 = (44C)_{16}$$

#### Rough

8 4 2 1      8 4 2 1      8 4 2 1

0 1 0 0      0 1 0 0      1 1 0 0

4      4      8+4

1      9      12=C

## 10. Hexadecimal to Binary number system conversion

To convert hexadecimal number to binary number follows the following steps:

- Write binary equivalent 4 digits group to each hexadecimal number.
- Give the result base 2.

### Examples:

i.  $(9A3)_{16} = (?)_2$

4 digits combination = 0100 0100 1100

Hexadecimal number = 9 A 3

Binary equivalent = 1001 1010 0011

$$(9A3)_{16} = (100110100011)_2$$

#### Rough

8 4 2 1            8 4 2 1            8 4 2 1

9                    A=10                3

8 4 2 1            8 4 2 1            8 4 2 1

1 0 0 1            1 0 1 0            0 0 1 1

ii.  $(B0D)_{16} = (?)_2$

Hexadecimal number = B 0 D

Binary equivalent = 1011 0000 1101

$$(B0D)_{16} = (101100001101)_2$$

#### Rough

B=11                0                    D=13

8 4 2 1            8 4 2 1            8 4 2 1

1 0 1 1            0 0 0 0            1 1 0 1

## 11. Octal to Hexadecimal number system conversion

To convert octal number to hexadecimal number follows the following steps:

- Write binary triple equivalent to each octal number
- Now, again form the group of four digits from right to left.
- Write respective hexadecimal number for each binary group.
- Give the result base 16.

### Examples:

i.  $(236)_8 = (?)_{16}$

Octal number = 2 3 6

Binary equivalent = 010 011 110

4 digits binary = 1 0 01 1 1 1 0

Hexadecimal equivalent = 9 E

$$(236)_8 = (9E)_{16}$$

### 12. Hexadecimal to Octal number system conversion

To convert hexadecimal number to octal number follows the following steps:

- Write binary equivalent 4 digits group to each hexadecimal number.
- Now, again form the group of three digits from right to left.
- Give the result base 8.

### Examples:

i.  $(9A3)_{16} = (?)_8$

Hexadecimal = 9 A 3

Binary equivalent = 1001 1010 0011

3 digits binary = 100 110 100 011

Octal equivalent = 4 6 4 3

$$(9A3)_{16} = (4643)_8$$

### Binary Calculation

Generally, there are four types of binary calculation. They are:

- Binary Addition,
- Binary Subtraction,
- Binary Multiplication and
- Binary Division.

## 1. Binary Addition

Binary addition is similar to decimal numbers addition. Some rules for adding binary numbers are:

$$0 + 0 = 0$$

$$0 + 1 = 1$$

$$1 + 0 = 1$$

$$1 + 1 = 10 \text{ (Write '0' here, carry 1 to next column)}$$

**Example:**

$$\begin{array}{r} 1010 \\ + 1101 \\ \hline 10111 \end{array}$$

Hence,  $1010 + 1101 = 10111$ .

## Binary Subtraction

Binary subtraction is similar to decimal number subtraction. Some rules for subtracting binary numbers are:

$$0 - 0 = 0$$

$$1 - 0 = 1$$

$$1 - 1 = 0$$

$$0 - 1 = 1 \text{ (with borrow 1 from the left column)}$$

$$\begin{array}{r} 10111 \\ - 101 \\ \hline 10010 \end{array}$$

Hence,  $10111 - 101 = 10010$ .

## Binary Multiplication

Binary multiplication is similar to decimal number multiplication. Some rules for multiplying binary numbers are:

$$\begin{array}{r} 0 \times 0 = 0 \\ 1 \times 0 = 0 \\ 0 \times 1 = 0 \\ 1 \times 1 = 1 \\ 1001 \\ \times 101 \\ \hline 1001 \\ 0000 \\ 1001 \\ \hline 101101 \end{array}$$

Hence  $1001 \times 101 = 101101$

## Binary Division

Binary division is similar to decimal number division. Some rules for dividing binary numbers are:

$$\begin{array}{l} 0 \div 0 = 0 \\ 0 \div 1 = 0 \\ 1 \div 1 = 1 \\ 1 \div 0 = \text{undefine} \end{array}$$

$$\begin{array}{r} 101 \ ) 11010 ( \ 101 \rightarrow \text{Quotient} \\ \underline{-101} \downarrow \\ 110 \\ \underline{-101} \\ 1 \rightarrow \text{Remainder} \end{array}$$

Hence, Quotient = 101

Remainder=1



## Bits, Nibbles, Bytes and Word

### Bits

Bits stands binary digits. It is the smallest unit of information in computer. It represents 0 or 1.

### Nibble

The combination of four bits is called a nibble. Examples: 1001, 1000, etc.

### Byte

The combination of eight bits is called a byte. Examples: 10111101, 10110110, 10011110, etc.

### Word

Word is the combination of bits. It is the number of bits which can process and transfer by processor. Computers usually have word size of 8 bits, 16 bits, 32 bits, 64 bits, 128 bits, etc.

The different measurement units of data in a computer are:

Bit = 1 or 0	1 Kilobyte = 1024byte	1 Petabyte= 1024 TB
1Crumb =2 bits	1 Megabyte= 1024 KB	1Exabyte = 1024 PB
1 Nibble = 4 bits	1 Gigabyte= 1024 MB	1Zettabyte = 1024EB
1 Byte = 8 bits or 2Nibble or 1character	1 Terabyte = 1024 GB	1Yottabyte = 1024 ZB

## Summary

- The group of digits or symbols used to express quantities as the basis for doing different calculations is called number system.
- Number system is differentiated by its base or radix.
- Decimal number system has base 10 as it uses 10 digits from 0 to 9.
- Binary number system has base 2 as it uses 2 digits 0 and 1.
- Octal number system has base 8 as it uses 8 digits from 0 to 7.

- Hexadecimal number system has base 16 as it uses 16 digits (10 digits and 6 letters, 0, 1, 2, 3, 4, 5, 6, 7, 8, 9, A, B, C, D, E, F).
- Computer uses binary, octal and hexadecimal number system according to its model or brand.
- A bit is the smallest unit of information on computer.

## Technical Terms

Number system	:	A set of symbols used to express quantities
Binary number	:	Number system consisting of digits 0 and 1
Octal number	:	Number system consisting of digits 0 to 7
Decimal number	:	Number system consisting of digits 0 to 9
Hexadecimal number	:	Number system consisting of 16 digits (0 to 9 and 6 letters-A to F)
Base	:	The total number of digits available in the number system
Byte	:	The combination of eight bits

## Exercises

### 1. Answer the following questions.

- What is the number system?
- Define base or radix of the number system.
- What is hexadecimal number system?
- What is computer word?
- Write different types of number system.
- How many bytes are there in 2GB?

### 2. Convert the given numbers as indicated.

a. Decimal to Binary Conversion.

- |                  |                    |                    |                   |                 |
|------------------|--------------------|--------------------|-------------------|-----------------|
| i. $(45)_{10}$   | ii. $(88)_{10}$    | iii. $(180)_{10}$  | iv. $(207)_{10}$  | v. $(444)_{10}$ |
| vi. $(875)_{10}$ | vii. $(1406)_{10}$ | viii. $(920)_{10}$ | ix. $(2090)_{10}$ | x. $(555)_{10}$ |

- b. Binary to Decimal Conversion.
- i.  $(1010)_2$     ii.  $(11100)_2$     iii.  $(10011)_2$     iv.  $(101110)_2$     v.  $(101011)_2$   
vi.  $(10110111)_2$     vii.  $(110011)_2$     viii.  $(100001)_2$   
ix.  $(101010)_2$     x.  $(111110)_2$
- c. Decimal to Octal Conversion.
- i.  $(56)_{10}$     ii.  $(123)_{10}$     iii.  $(437)_{10}$     iv.  $(279)_{10}$     v.  $(555)_{10}$   
vi.  $(684)_{10}$     vii.  $(808)_{10}$     viii.  $(901)_{10}$     ix.  $(1723)_{10}$     x.  $(2078)_{10}$
- d. Octal to Decimal Conversion.
- i.  $(114)_8$     ii.  $(234)_8$     iii.  $(444)_8$     iv.  $(567)_8$     v.  $(601)_8$   
vi.  $(723)_8$     vii.  $(1230)_8$     viii.  $(2233)_8$     ix.  $(732)_8$     x.  $(711)_8$
- e. Decimal to Hexadecimal Conversion.
- i.  $(76)_{10}$     ii.  $(106)_{10}$     iii.  $(321)_{10}$     iv.  $(808)_{10}$     v.  $(2047)_{10}$   
vi.  $(2019)_{10}$     vii.  $(5544)_{10}$
- f. Hexadecimal to Decimal Conversion.
- i.  $(98)_{16}$     ii.  $(1067)_{16}$     iii.  $(888)_{16}$     iv.  $(AC5)_{16}$     v.  $(A02)_{16}$   
vi.  $(FED)_{16}$     vii.  $(1E1)_{16}$     viii.  $(8A0)_{16}$
- g. Binary to Octal Conversion.
- i.  $(100)_2$     ii.  $(1010)_2$     iii.  $(11001)_2$     iv.  $(100100)_2$     v.  $(11100)_2$   
vi.  $(110110)_2$     vii.  $(111110)_2$     viii.  $(11001100)_2$
- h. Octal to Binary Conversion.
- i.  $(64)_8$     ii.  $(104)_8$     iii.  $(224)_8$     iv.  $(333)_8$     v.  $(467)_8$   
vi.  $(524)_8$     vii.  $(667)_8$     viii.  $(7004)_8$
- i. Binary to Hexadecimal Conversion.
- i.  $(100)_2$     ii.  $(1010)_2$     iii.  $(11100)_2$     iv.  $(110011)_2$     v.  $(101010)_2$   
vi.  $(100110)_2$     vii.  $(11001100)_2$     viii.  $(1100111)_2$
- j. Hexadecimal to Binary Conversion.
- i.  $(81)_{16}$     ii.  $(105)_{16}$     iii.  $(981)_{16}$     iv.  $(1AC)_{16}$     v.  $(B0F)_{16}$   
vi.  $(BCD)_{16}$     vii.  $(7BF)_{16}$     viii.  $(90E)_{16}$

k. Octal to Hexadecimal Conversion.

- i.  $(64)_8$       ii.  $(124)_8$       iii.  $(205)_8$       iv.  $(5434)_8$       v.  $(1150)_8$   
vi.  $(345)_8$       vii.  $(734)_8$       viii.  $(7314)_8$

l. Hexadecimal to Octal Conversion.

- i.  $(894)_{16}$       ii.  $(1AC)_{16}$       iii.  $(BAD)_{16}$       iv.  $(10001)_{16}$       v.  $(AB6)_{16}$   
vi.  $(B00)_{16}$       vii.  $(ABC)_{16}$

### 3. Calculate the following as indicated.

a. Perform the following binary addition.

- i.  $(10100)_2 + (1101)_2$       ii.  $(1011)_2 + (1101)_2$   
iii.  $(10111)_2 + (1111)_2$       iv.  $(1110)_2 + (1110)_2$   
v.  $(10100)_2 + (10011)_2$       vi.  $(111001)_2 + (101100)_2$   
vii.  $(100111)_2 + (11010)_2$       viii.  $(100100)_2 + (110011)_2$

b. Perform the following binary subtraction.

- i.  $(1100)_2 - (1000)_2$       ii.  $(1100)_2 - (100)_2$   
iii.  $(10100)_2 - (110)_2$       iv.  $(101100)_2 - (10011)_2$   
v.  $(1100111)_2 - (1011)_2$       vi.  $(110011)_2 - (10100)_2$   
vii.  $(100100)_2 - (11010)_2$       viii.  $(1000010)_2 - (110101)_2$

c. Perform the following binary multiplication.

- i.  $(110)_2 \times (11)_2$       ii.  $(101)_2 \times (10)_2$   
iii.  $(111)_2 \times (11)_2$       iv.  $(1100)_2 \times (101)_2$   
v.  $(11010)_2 \times (110)_2$       vi.  $(101100)_2 \times (100)_2$   
vii.  $(11001)_2 \times (1100)_2$       viii.  $(11000)_2 \times (1001)_2$

d. Perform the following binary division.

- i.  $(111)_2 \div (10)_2$       ii.  $(10110)_2 \div (10)_2$   
iii.  $(1101)_2 \div (11)_2$       iv.  $(101101)_2 \div (101)_2$   
v.  $(111010)_2 \div (110)_2$       vi.  $(100101)_2 \div (110)_2$   
vii.  $(1000100)_2 \div (1100)_2$       viii.  $(1110011)_2 \div (1010)_2$

e. Perform the following binary simplification.

i.  $(11 \times 10)_2 + (11)_2$

ii.  $(10 \times 11)_2 + (101)_2$

iii.  $(1001 + 110)_2 - (1000)_2$

iv.  $(1010 \times 110)_2 \div (10)_2$

v.  $(100110 + 110)_2 \div (110)_2$

vi.  $(10011)_2 \times (101)_2$

vii.  $(1000 + 100)_2 \div (11)_2$

viii.  $(11100-11)_2 \times (100)_2$

## Project Work

---

1. Draw the “conversion of different number system” on a sheet of chart paper and paste it in your class room.
2. Prepare a presentation about different types of number system on computer and present in your class as group work.

# Database Management System

## 2.1 Introduction to Database Management System

Every organization have to maintain data concerning their activities, business, transaction, employees etc. For example, your school maintains data regarding a student's general information, academic performance, punctuality and discipline. These data need to be kept in such a way that it can be readily available and can be presented easily in desired formats. The data also needs to be updated and appended regularly. Actually, these data are manually maintained in various files in most cases.

As you can notice in the below Table - Telephone directory, it has information distributed under the headings, such as S.No. Name, Address, Telephone Number. Furthermore, the entire information is alphabetically organized for easy retrieval.

**Table - Telephone Directory**

S.No.	Name	Address	Telephone No.
1.	Arjun Yadav	Janakpur, Nepal	041-634544
2.	Hari Chaudhary	Dang, Nepal	082-520907
3.	Bishnu Devkota	Kavre, Nepal	011-543678

Well organized information as above is database. In other words, a collection of systematically organized inter-related data is called a database.

### Data and Information

Raw form of any facts, figures or entities are known as data. Data alone does not give any meaning. For example, Aaradhya, 1000, account, balance etc. are raw data individually does not give any meaning.

The processed form of data is known as information. When the data becomes information it gives meaningful result. For example, Aaradhya has 1000 balance in his bank account. Here Aaradhya, 1000, account, balance all have their significant meaning. Thus, we can say that information is the organized collection of inter-related data.

## Purpose of Database

Database is used to store, organize and retrieve data. Database can be computerized and non-computerized (manual). A database may have single table or multiple tables. The data in a database are organized in rows and columns. Some examples of database are Telephone directory, mark ledger, attendance register, dictionary etc.

## Database Management System (DBMS)

Database management system (DBMS) is a computerized system that stores data, processes them and provides information in an organized form. DBMS basically deals with the creation of database, its management and retrieval process. Creating, modifying, updating, appending, organizing, sorting, removing, and retrieving are the major tasks performed easily, efficiently and accurately using Database management system. Some of the popular DBMS software are MS-Access, Oracle, MS-SQL Server, MySQL, PostgreSQL etc.



These DBMS are capable to handle records in multiple tables on the basis of a key field. It allows a user to view or retrieve records from the multiple linked tables continuously at a time.

## Features of DBMS

The following are the features of a DBMS:

- Large volume of data can be stored and updated easily.
- Provides data integrity and security.
- Easy in data administration or data management.
- Provides the data sharing facility.
- Reduces the data redundancy (duplication of data).
- Provides concurrent access, recovers the data from the crashes.
- Supports centralized control

## Components of Database

### Table

Database is composed of one or more tables. Tables are the building block of database. A single table is used to store data of a specific purpose or subject such as telephone directory, book records in library etc. Since entire data is managed and kept in a table for the future retrieval process it is also called the primary object of database. Table stores large volume of data into rows called records and column called field. When fields and records are combined forms a complete table.

**Table - Book Records**

Code	Book Name	Level	Author	Year of Publication
B302	Computer Science	Secondary	Jyoti Jha	2009 AD
B304	Elementary Maths	Higher Secondary	Keshav Pant	2010 AD
C209	DBMS	Bachelor	Hari Bhattraai	2012 AD
M405	Micro Economics	Masters	Govinda Rana	2007 AD

### Record

A record or row contains information about single items in a database. It is also called tuple. For example, in Table – Book Records, all the information about a book is record. Here, the combination of Code, Book Name, Level, Author, Year of Publication values forms a record.

Code	Book Name	Level	Author	Year of Publication
B302	Computer Science	Secondary	Jyoti Jha	2009 AD

### Field

A field or column contains information about a certain type for all records. It is also known as attributes. For example, in Table – Book Records, Code, Book Name, Level, Author, Year of Publication are the fields of book records table.

Book Name
Computer Science
Elementary Maths
DBMS
Micro Economics



## Summary

- A collection of systematically organized inter-related data is called a database.
- Raw form of any facts, figures or entities are known as data.
- The processed form of data is known as information.
- Database management system (DBMS) is a computerized system that stores data process them and provide information in an organized form.
- Some of the popular DBMS software are MS-Access, Oracle, MS-SQL Server, MySQL, PostgreSQL etc.
- Tables are the building block of database.
- A record or row contains information about single items in a database.
- A field or column contains information about a certain type for all records.

## Exercises

### 1. Answer the below questions.

- What is database? Give some examples of database.
- Differentiate between data and information.
- What is DBMS? Name any four DBMS software.
- What are the components of database?

### 2. Choose the correct answer.

- ..... is the collection of related information.  
i. Data            ii. Meta data        iii. Database        iv. Facts
- ..... is the raw form of any facts and figures.  
i. Information    ii. DBMS            iii. Records        iv. Data
- ..... is a DBMS software.  
i. MS-Access    ii. MS-Excel        iii. bdase            iv. None of them
- A ..... is a collection of data about a specific topic.  
i. DBMS            ii. Database        iii. Table            iv. All of them

- e) In a table, row is called ..... and column is called .....
- i. record, field    ii. field, record    iii. record, tuple    iv. None of them

**3. State whether the following statements are 'True' or 'False'.**

- a) Collection of any data can be a database.
- b) MS-Access is an example of DBMS.
- c) Every record in a table is unique.
- d) A group of related field that describes a person, place, or thing is called a field.
- e) DBMS is an application software
- f) Deleting a field does not delete data in the field.

## 2.2 Creating Database Using Microsoft Access

### An Introduction to Microsoft Access

MS-Access is DBMS software developed by Microsoft Corporation. This software is distributed along with the Microsoft Office application package. Microsoft Access 2019 is the latest version available in the market.

The Access database consists of several different components. Each component is called an object. Access consists of seven objects. The various objects of MS-Access are Tables, Queries, Forms, Reports, Pages, Macros and Modules. All objects of a database are stored in a single file, and the extension of database file is .accdb.

### Main features of MS-Access

- a) Creates sophisticated database quickly.
- b) Analyse and modified your data easily with queries.
- c) Creates elaborated reports from your data.
- d) Makes customized data entry forms.
- e) Presents your data dynamically on the WWW (World Wide Web).

### We will explore mainly the following four objects of MS-Access

#### a) Tables

All databases must have at least one table. Tables are the primary building block of database. All data are stored and managed in a table. Every table in a database focuses on one specific subject. Table stores large volume of data into rows and column.

#### b) Queries

A query is simply the question that we ask about the data stored in the table. Query is also used to perform various actions on the data. For example, "Show the names of students who have scored greater than or equal to 80 marks in science." "Update the salary of employees by 10%."

#### c) Forms

Forms are the graphical interface used to enter data into the tables or multiple linked

tables. Forms are also used to display the information in specific manner, as well as it permits user to add, modify and delete data in a table. Primarily, fields in the table or query are made available to place in the forms that we create.

#### d) Reports

Reports are the presentation of information in desired format. Reports are generally created for the printing purpose of any desired information. With Access, we can create reports of any table or query. For example, report card of your final examination.

#### Starting MS-Access

Follow the below steps to run MS-Access:

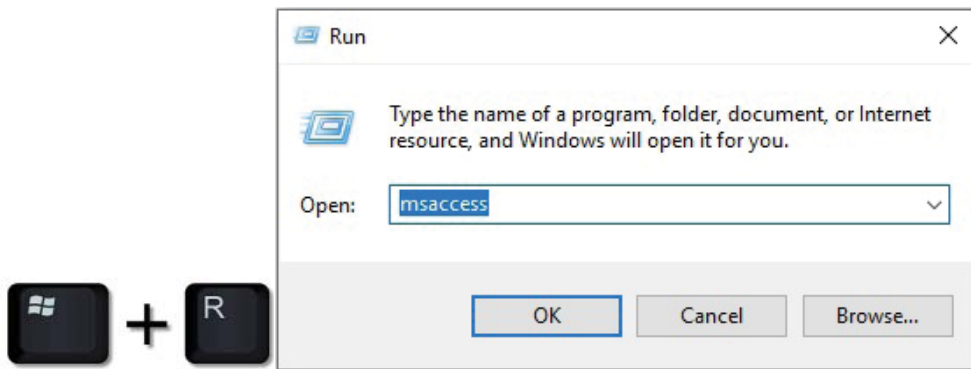

Step 1: Press Windows Key and R at the same time. Run window appears.

Step 2: Type 'msaccess' as shown in the figure alongside.

Step 3: Finally click on OK button.

#### Creating a new database file

When MS-Access is started, it gives user a choice of either creating a new database or opening an existing database. Follow the below steps to create a new database file:

Step 1: Click on the **Blank desktop database**.

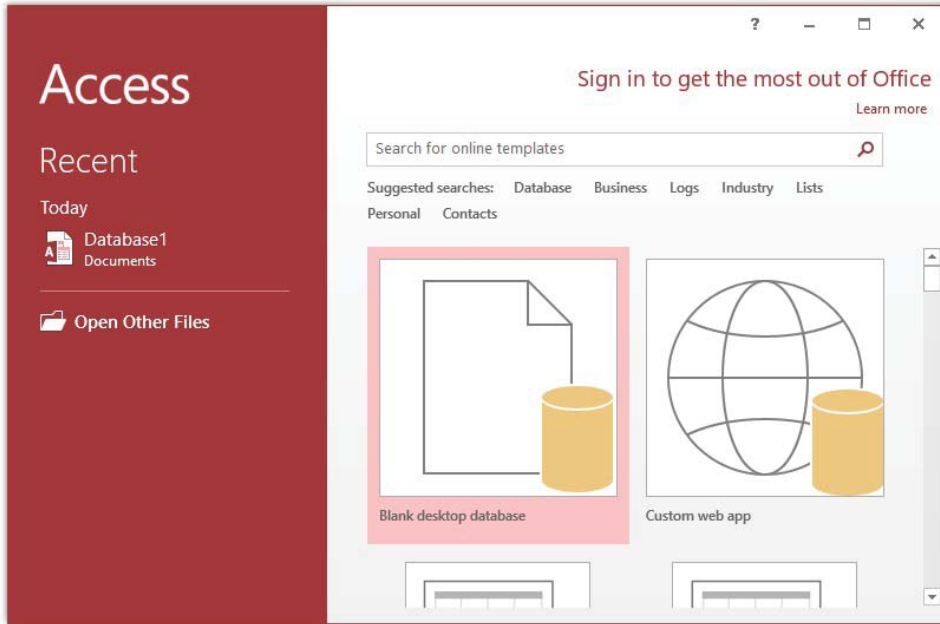

A Blank desktop database dialog box will appear.

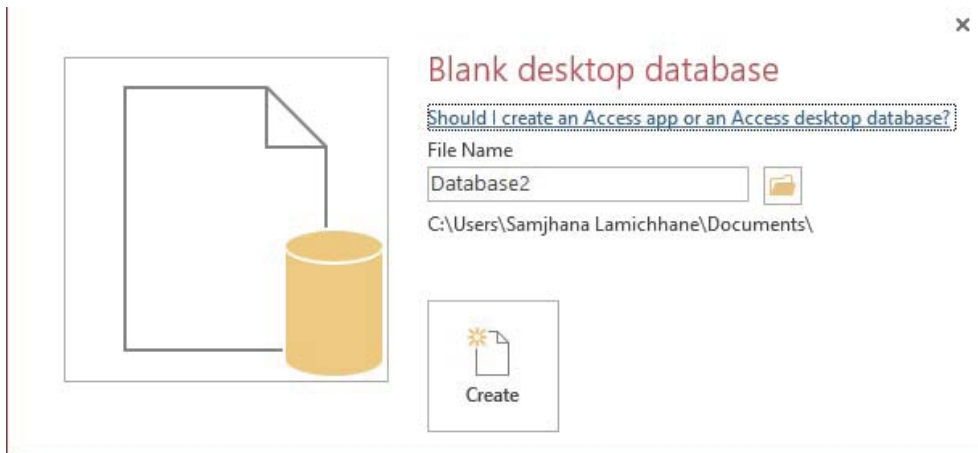

Step 2: Type the File Name.

Step 3: Choose the required folder where you want to save.

Step 4: Click on Create button.

## Creating Table in MS-Access

Follow the below steps to create a table:

Step 1: From Create tab, click on Table Design button of Tables group.

Step 2: Add the required Field Name and Data Type.

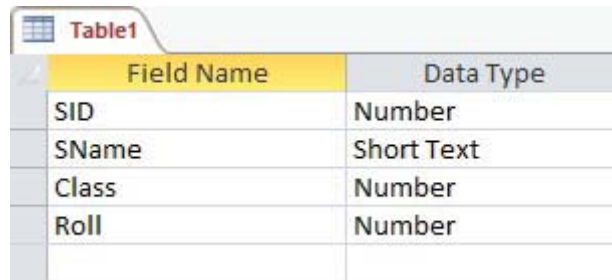

The screenshot shows the Table Design view for a table named 'Table1'. The table has four columns: 'Field Name' and 'Data Type'. The rows are: 'SID' with 'Number', 'SName' with 'Short Text', 'Class' with 'Number', and 'Roll' with 'Number'.

Field Name	Data Type
SID	Number
SName	Short Text
Class	Number
Roll	Number

Step 3: Right click on the Table1 tab in the above figure.

Step 4: Type Table name. Click on OK.

**Note:** A field name can be up 40 characters long.

## Adding Fields in a table

Follow the below steps to add a field in an existing table:

Step 1: Open the database and open the table.

Step 2: Right click on the field above which you want to add a new field.

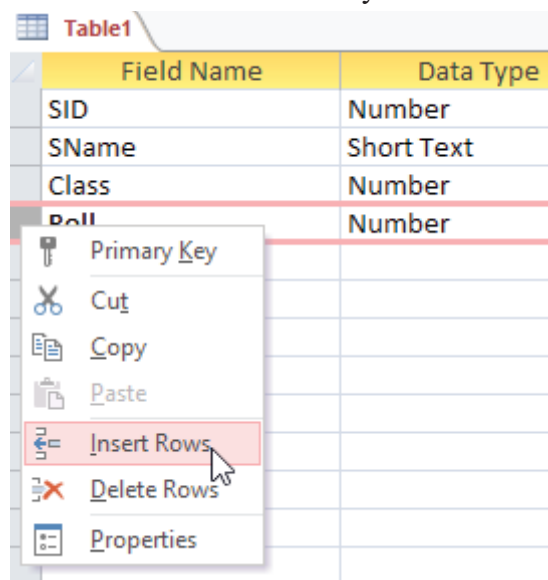

The screenshot shows the Table Design view for a table named 'Table1'. The table has four columns: 'Field Name' and 'Data Type'. The rows are: 'SID' with 'Number', 'SName' with 'Short Text', 'Class' with 'Number', and 'Roll' with 'Number'. A context menu is open over the 'Roll' row, with the 'Insert Rows' option highlighted.

Field Name	Data Type
SID	Number
SName	Short Text
Class	Number
Roll	Number

- Primary Key
- Cut
- Copy
- Paste
- Insert Rows**
- Delete Rows
- Properties

Step 3: Click on Insert Rows. A new blank field is inserted above the selected field.

Step 4: Type Field Name and Data Type.

### Deleting Fields in a table

Follow the below steps to add a field in an existing table:

Step 1: Open the database and open the table.

Step 2: Right click on the field which you want to delete.

Step 3: Click on Delete Rows.

### Defining Data types

Data type determines the kind of values that you can store in the field. After you enter the valid field name, it allows a user to select the data type for the field. You can use the Data Type property to specify the type of data stored in a table field such as text for name field, number for class field, Date and time for DOB field etc. Each field can store data consisting of only a single data type. MS-Access supports the following data types:

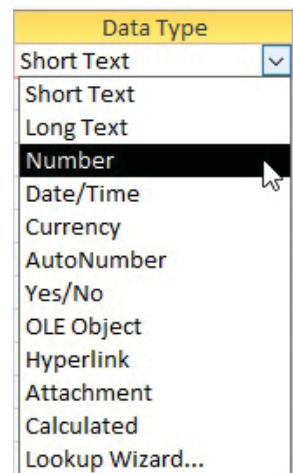

**Table - MS-Access Data types**

Data Type	Description	Maximum Data / Space	Default Field Size
Short Text	Used for text or combinations of text and numbers, as well as numbers those don't require calculations, such as phone numbers.	Up to 255 Characters	255
Long Text	Lengthy text or combinations of text and numbers.	Up to 64,000 Characters	–
Number	Used for data to be included in mathematical calculations.	1,2,4 or 8 Bytes	Long Integer
- Byte	Stores numbers from 0 to 255 without decimals.	1 byte	

- Integer	Stores numbers from -32768 to +32768 without decimals.	2 bytes	
- Long Integer	Stores numbers from -2147483648 to +2147483647 without decimals.	4 bytes	
- Single	Single precision floating point numbers from $-3.4 \times 10^{-38}$ to $3.4 \times 10^{38}$ .	4 bytes, 7 decimal places	
- Double	Double precision floating point numbers from $-1.797 \times 10^{-308}$ to $1.797 \times 10^{308}$ .	8 bytes, 15 decimal places	
Date/Time	Used for dates and time data.	8 Bytes	
Currency	Used for currency values.	8 Bytes	-
Auto Number	Used for unique sequential (incrementing by 1).	4 Bytes	-
Yes/No	Used for data that can be only one of two possible values, such as Yes/No.	1 Bit	-
OLE Object	Used for OLE objects (such as MS-Word documents, MS-Excel spread sheets, pictures, sounds).	Up to about 2 GB	-
Hyperlink	Used for hyperlinks.	Up to 2048 Characters	-
Attachments	To attach any supported type of file	Up to about 2 GB	-
Lookup Wizard	Used to create a field that allows you to choose a value from another table	Dependent on the data type of the lookup field	-

### Field Description

You can enter the description of each field in the Description column. It helps you to remember the use and purpose of a particular field. This is an optional part in a database. It is displayed in the status bar when you select this field on a form.



Field Name	Data Type	Description (Optional)
SID	Number	Student's ID
SName	Short Text	Name of students

*Primary Key field*

## Primary Key

Primary Key is a special field or group of fields in the table that uniquely identifies each record from the database. To distinguish one record from another, table must contain a unique field named as primary key. The primary key does not accept duplicate value for a field and it does not allow a user to leave the field blank or null. The primary key is an identifier such as a student ID, a Product code, Exam roll no. etc. Hence, primary key is unique to each record.

## Importance of Primary Key

- To identify each record of a table uniquely.
- To reduce and control duplication of the record in a table.
- To set the relationship between tables.

## Setting the Primary Key

Follow the below steps to create a primary key field:

- Step 1: Open the table in **Design View**.
- Step 2: Click on the field in which you want to apply primary key.
- Step 3: Click on **Design** tab.
- Step 4: Click on **Primary Key** button from **Tools** group.

A key icon will be displayed on the left side of the primary key field.

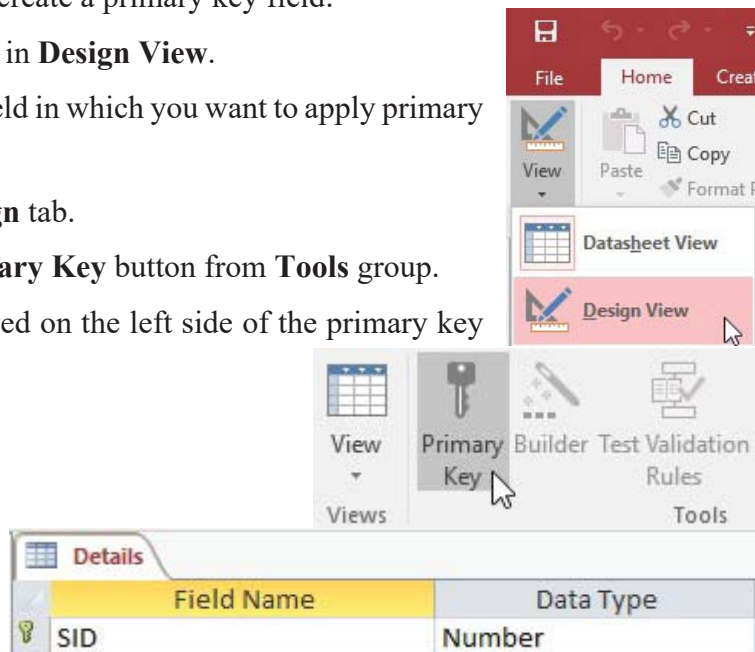

## Field Properties Pane

Field properties pane displays list of properties associated with each field data type. To control over the contents of a field we can set the field size, format, validation rule etc.

The general properties of fields are given below:

General	Lookup
Field Size	255
Format	
Input Mask	
Caption	
Default Value	
Validation Rule	
Validation Text	
Required	No
Allow Zero Length	Yes
Indexed	No
Unicode Compression	Yes
IME Mode	No Control
IME Sentence Mode	None
Text Align	General

*Field Properties – ShortText*

General	Lookup
Field Size	Long Integer
Format	
Decimal Places	Auto
Input Mask	
Caption	
Default Value	0
Validation Rule	
Validation Text	
Required	No
Indexed	No
Text Align	General

*Field Properties – Number*

### a. Field Size

You can use the Field Size property to set the maximum size for data stored in the field that is set to the Text or Number data type.

For Text data, the amount of data that you can store can be determined by the number of characters you wish to store on it. Maximum is 255 characters.

For numeric data, the field size can be set depending upon the type and range of value you wish to store. Below table explains about the numeric data range and storage.

Field Size Setting	Range of Values	Decimal Places	Storage Size (in Bytes)
Byte	0 to 255	None	1
Integer	-32768 to 32767	None	2
Long Integer	2147483648 to +2147483647	None	4
Single	-3.4 x 10 <sup>-38</sup> to 3.4 x 10 <sup>38</sup> .	7	4
Double	-1.797 x 10 <sup>-308</sup> to 1.797 x 10 <sup>308</sup>	15	8

## b. Caption

Caption field property is the alternative name given for any field. This helps to make field name more explanatory. The maximum size for this is 2048 characters. It is also a label for a field when used on a form. If caption is not entered, field name is used for label for a field on a form.

## c. Default Value

Default Value field property is one that is displayed automatically for the field when you add a new record to the table.

## d. Format

Format field property allows you to display data in a format different from the way it is actually stored in a table. It is also known as display layout for a field. Depending on the type of data, the option in the Format menu will differ.

## e. Input Mask

Input mask field property specifies the pattern of data that you wish to enter into the specific field. It is simply the control over the data entry. This field property does a couple of tasks in a field. They are:

- It forces you to enter field values in a specified pattern.
- It can fill in constant characters like dash (-), parenthesis ( ) and slash (/) and optionally store these characters as part of the field value as you do not have to enter these characters at the time of data entry.

## f. Validation Rule

It is used to limit the values that can be entered into a field. Data validation in various cases are explained in the below table.

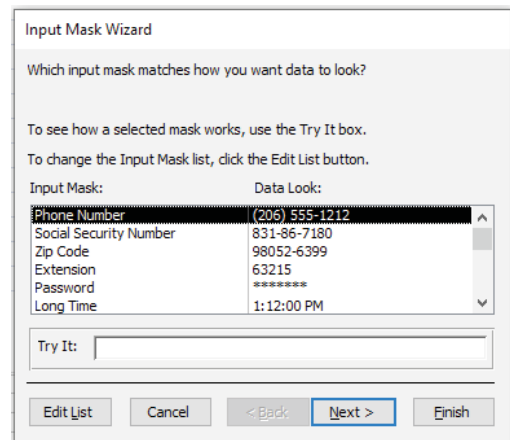

<b>Expression</b>	<b>Example</b>	<b>Description</b>
Validation expression for numbers		
<	<100	Entered value must be less than 100.
>	>50	Entered value must be greater than 50.
<>	<>0	Entered value must be not equal to 0.
<=	<=100	Entered value must be less than or equal to 100.
>=	>=50	Entered value must be less than or equal to 50.
=	=10	Entered value must be equal to 10.
Between .... and ...	Between 0 and 100	Entered value must be within the range of 0 to 100.
Validation expression for dates		
	< # 1/30/2012 #	Entered date must be before January 30, 2012.
	> # 1/30/2010 5:30 PM #	Entered date must be after January 30, 2010 and after 5:30 PM.
	<= #1/30/2012 #	Entered date must be before or on January 30, 2012.
	>= # 1/30/2010	Entered date must be after or on January 30, 2010.
	> Date()	Entered date must be after the current date.
	< Date()	Entered date must be before the current date.
	> Now()	Entered date must be today after the current time or any other day in future.
	< Now()	Entered date must be today before the current time or any other day in past.
Validation expression for texts		
Like	Like "B*"	Here * represents zero or more characters. It checks that the value starts with B (or b), followed by zero or more characters.
	Like "*up"	It checks whether text ends with characters "up".
	Like "?????UP"	Here? represents one character. It accepts 7 characters and ends with UP.
	Like "#####CSX"	Here # also represents one character but it is number. It accepts 7 characters and ends with CSX and preceded by five numbers.
	Like "[BO]????"	It accepts 5 characters and first character is either B or O.
	Like "[A-Z] [A- Z] [A-Z] [A-Z]"	It accepts four characters (Only letters). [A-Z] represents characters ranges from A to Z.

Validation expression with Boolean operators		
AND	>=10 AND <=50	Entered value must be within the range of 10 to 50
OR	>500 OR <100	Entered value must be either greater than 500 or less than 100.

### g. Validation Text

Validation Text is the error message that appears if the data entered is invalid according to the specified validation rule.

General	Lookup
Field Size	255
Format	
Input Mask	
Caption	
Default Value	
Validation Rule	"A" Or "B"
Validation Text	Please type A or B Only
Required	No
Allow Zero Length	Yes
Indexed	No

*Validation Rule for Section Field – "A" Or "B"*

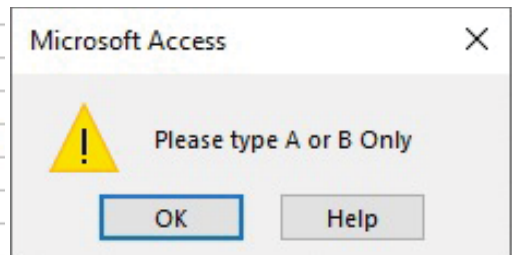

*Validation Text Message Box*

### h. Required

You can use required property to specify whether a value is required in a field or not. So, Yes and No are the options for required property. If this property is set to Yes for a field, the field must receive value during data entry. If this property is set to No for a field, the field can be left blank.

### i. Indexed

You can use the Indexed property to set an index on a field. It speeds up searching and sorting of records based on a field. For example, if you search for specific student name in a SName field, you can create an index for this field to speed up the search for the specific name. By default, indexed property is set as No. It also uses other two settings.

**Table - Indexed property settings**

Setting	Description
No	No indexing.
Yes (Duplicates OK)	The index allows duplicates.
Yes (No Duplicates)	The index does not allow duplicates.

## Summary

- MS-Access is DBMS software developed by Microsoft Corporation. It is distributed with MS-Office package.
- Tables, Queries, Reports and Forms are the four main objects of MS-Access database.
- Tables are the primary building block of database.
- Data type determines the kind of values that you can store in the field.
- Data Type supported by MS-Access are Short Text, Long Text, Number, Date/Time, Currency, AutoNumber, Yes/No, OLE Object, Hyperlink, Attachment and Lookup Wizard.
- Primary Key is a special field or group of fields in the table that uniquely identifies each record from the database.
- Caption is the alternative name given for any field.
- Indexed property speeds up searching and sorting of records based on a field.

## Exercises

### 1. Answer the below questions

- a) List any four features of MS-Access.
- b) What is a database? Give any two examples.
- c) What is database object? List any four database objects.
- d) What does data type? Name any four data types in MS-Access.
- e) Which data type is used to store numeric characters or special symbols in MS-Access?

- f) What is primary key? Why is it important to specify?
- g) List any four advantages of primary key.
- h) What are field properties? Name any four of them.
- i) Define indexing. Mention its importance.

**2. Choose the best answer.**

- a) What is extension of access database file?
  - i. .DBF                      ii. .ACCDB                      iii. .MBD                      iv. ii & iii
- b) Object primarily used to store the data in database.
  - i. Table                      ii. Form                      iii. Query                      iv. Report
- c) A field name can be up to ..... characters long.
  - i. 40                      ii. 46                      iii. 64                      iv. 2048
- d) ..... is a data type used for lengthy text and numbers
  - i. Text                      ii. Long Text                      iii. OLE Object                      iv. Lookup Wizard
- e) Data type that requires 8 bytes of storage.
  - i. Yes/No                      ii. Currency                      iii. Long Integer                      iv. All of them
- f) The name of caption can be declared up to ..... characters.
  - i. 1024                      ii. 2024                      iii. 2048                      iv. 2005
- g) Memory Space used by an auto number data type is .....
  - i. 1 Byte                      ii. 2 Bytes                      iii. 4 Bytes                      iv. 8 Bytes

**3. State whether the following statements are 'True' of 'False'.**

- a) Lookup Wizard is a tool that automates many database tasks.
- b) Default field size of text type of data is 65535 characters.
- c) Date/Time type of data requires 8 bytes of memory.
- d) Removing a primary key does not delete a field.
- e) Validation rule is used to specify whether a value is required in a field.
- f) Indexed field property speeds up searching and sorting of records based on a field.

**4. Match the following**

**a. Group A**

Number

Yes/No

Currency

Text

**Group B**

i. 255

ii. 8 Bytes

iii. Long integer

iv. 1 bit

v. Short integer

**b. Group A**

Data Redundancy

Validation Text

Input Mask

Validation Rule

**Group B**

i. Error message

ii. Pattern of data in a field

iii. Lookup wizard

iv. Data duplication

v. Limits the values

**c. Group A**

Indexing data

Long text

FoxPro

Label for a field

**Group B**

i. Retrieves data

ii. Caption

iii. Memo field

iv. DBMS

v. Searching fast

**5. Write the most appropriate technical term of following statements.**

- Field property that limits the values that can be entered into a field
- The value automatically enters for the new record
- A field or a group of fields that uniquely identifies the records in database.
- A message displayed after data is entered and checked into a field.
- Field property that defines label for the field



## 2.3 Entering and Editing Data

### Table Datasheet and its Formatting

Table datasheet is simply the display of records in row and column format. Using the datasheet view, you can add, modify, search or delete records. There are mainly two views of Table.

- a) **Design View** – Related with table structure. You can add, edit or delete field and its properties.
- b) **Datasheet View** – Related with records. You can add, modify, search or delete records.

### Switching to Datasheet View:

Follow the below steps to switch from Design View to Datasheet View:

- Step 1: Click on the Design Tab.
- Step 2: Click on View drop-down button from Tools group.
- Step 3: Click on Datasheet View.

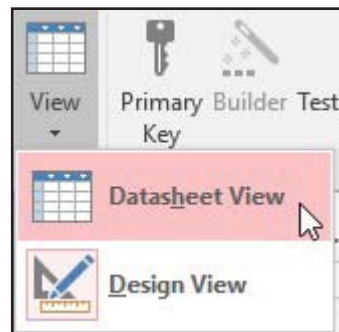

### Adding Records in a Datasheet

After the table is created through design view option, you open it in datasheet to enter the records. Follow the below steps to add records in datasheet:

- Step 1: After you, open datasheet mouse cursor will be placed in the first field of first record. Type the required data in the field.
- Step 2: Press Tab or Arrow to move to the next field. Or, simply place the mouse cursor in the desired field.
- Step 3: While entering the data in a field, next row for new record will be automatically displayed. For example, if you are entering the record in first row, second row automatically appears. Repeat the above steps to enter the data in fields till required.

Step 4: After finishing the adding records in the datasheet, you can close the datasheet simply by clicking on close button.

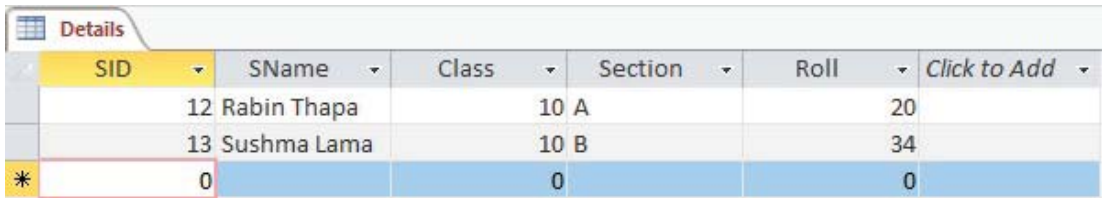

SID	SName	Class	Section	Roll	Click to Add
12	Rabin Thapa	10	A	20	
13	Sushma Lama	10	B	34	
*	0	0	0	0	

## Modify Records in a Datasheet

You can open the existing table and can modify the data in datasheet. Follow the below steps to modify records in datasheet:

Step 1: Open the table in Datasheet View.

Step 2: Put the mouse cursor in the desired cell.

Step 3: Type new value or edit the existing value of the desired cell.

## Delete Records from a Datasheet

You can remove the unwanted records of the datasheet. Follow the below steps to delete records in datasheet:

Step 1: Open the table in a Datasheet View.

Step 2: Right-click on the square box left to the record which you want to delete. A pop-up menu will appear.

Step 3: Click on Delete Record option. A message box will appear.

Step 4: Click on Yes.

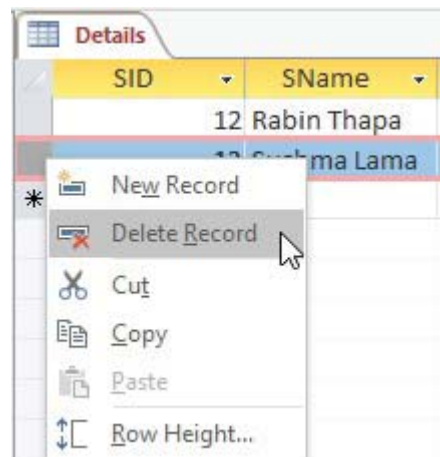

## Hiding the columns or fields

You can temporarily hide a column(s) or field(s) so that you can view more columns in a larger datasheet. Follow the below steps to hide fields:

Step 1: Right-click on the column heading

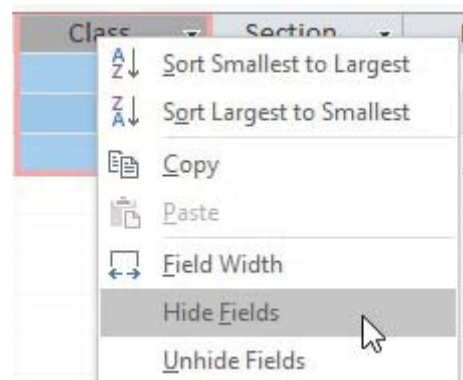

(field name) which you want to hide. A pop-up menu will appear.

Step 2: Click on Hide Fields option.

### Unhide the hidden fields

Follow the below steps to unhide the hidden columns:

Step 1: Open the table in Datasheet View.

Step 2: Right-Click on any Column heading. A pop-up menu will appear.

Step 3: Click on Unhide Fields option. An Unhide Columns dialog box will appear with the list of fields.

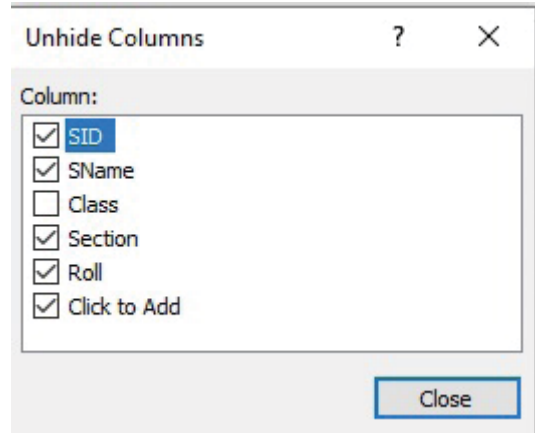

Step 4: Click on the check box of required field to unhide.

Step 5: Click on Close.

### Freeze Columns

You can freeze one or more columns on a datasheet so that they become the leftmost columns and are visible at all times no matter wherever you scroll. Follow the below steps to freeze column(s):

Step 1: Open the table in **Datasheet View**.

Step 2: **Right-Click** on the column heading which you want to freeze. A pop-up menu will appear.

Step 3: Click on **Freeze Fields** option.

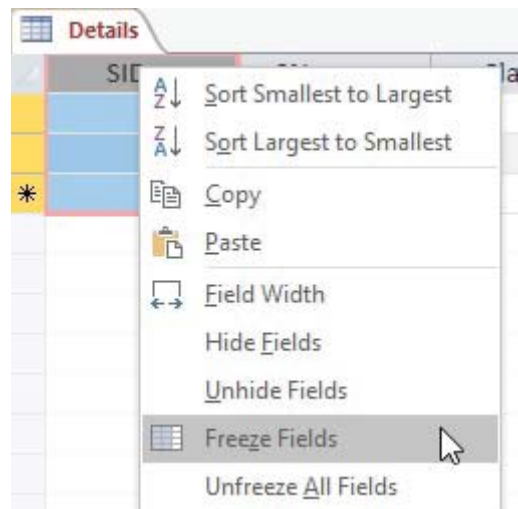

## Unfreeze Columns

You can unfreeze columns on a datasheet. Follow the below steps to unfreeze column(s):

Step 1: **Right-Click** on the column heading. A pop-up menu will appear.

Step 2: Click on **Unfreeze All Fields** option.

## Adjusting Column Width

In datasheet we can adjust the column width as required to fit the data in the field. In some case field might contain the longer data that might not be easily visible and in other case field might contain the short data that taking unnecessary longer width. So, to improve from this inefficient view of datasheet we have to adjust the column width. This can be done in the following ways.

### Method #1

By dragging the field sizing line from the right most corner of the field header.

GENDER	ROLL NO	NAME
--------	---------	------

### Method #2

By double clicking on the field sizing line.

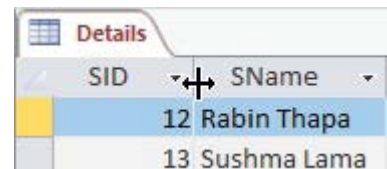

SID	SName
12	Rabin Thapa
13	Sushma Lama

### Method #3:

By setting the fixed width in a column width dialog box.

Step 1: Right-Click on the header of column.

Step 2: Click on Field Width option. A Column Width dialog box will appear.

Step 3: Type the required width value.

Step 4: Click on OK.

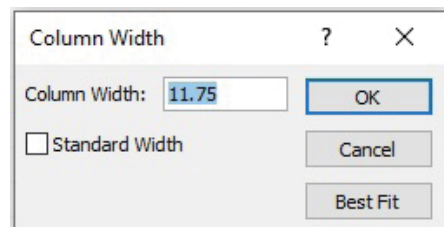

Column Width ? X

Column Width: 11.75 OK

Standard Width Cancel

Best Fit

## Adjusting Row Height

In datasheet we can also adjust the height of row as required to fit the records in the row. This can be done in below mentioned two ways.

### Method #1

By dragging the row sizing line from the bottom most corner of the row.



### Method #2

By setting the row height in a Row Height dialog box.

- Step 1: Right-Click on the square box left to the required row. A pop-up menu will appear.
- Step 2: Select Row Height option. A Row Height dialog box will appear.
- Step 3: Type the required row height.
- Step 4: Click on OK.

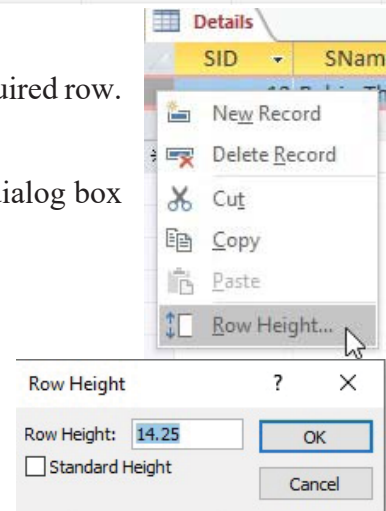

## Sorting Records

The process of arranging all the records in a table either ascending or descending order based on field or fields is known as sorting.

- Text types of data are sorted in alphabetical order (i.e. A to Z or Z to A).
- Date and Time data are sorted from oldest to newest or newest to oldest.
- Number/Currency types of data are sorted in smallest to largest or largest to smallest.

Follow the below steps to sort data of Short Text field:

- Step 1: Open the table in Datasheet View.

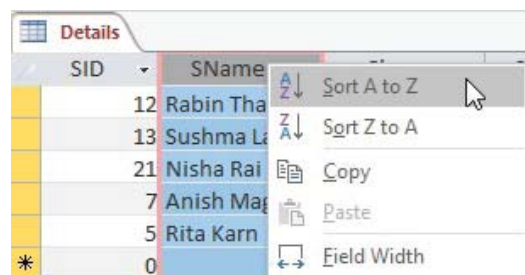

Step 2: Right-Click on the column heading of a field which you want to sort. A pop-up menu will appear.

Step 3: Click on Sort A to Z option.

The data will be sorted in alphabetical order.

SID	SName	Class	Section	Roll
5	Rita Karn	10 B		5
7	Anish Magar	10 A		12
12	Rabin Thapa	10 A		20
13	Sushma Lama	10 B		34
21	Nisha Rai	10 B		17

*Before Sorting*

SID	SName	Class	Section	Roll
7	Anish Magar	10 A		12
21	Nisha Rai	10 B		17
12	Rabin Thapa	10 A		20
5	Rita Karn	10 B		5
13	Sushma Lama	10 B		34

*After Sorting*

Field with Memo, Hyperlink and OLE Objects data types cannot be sorted. After the sorting process, you need to save the table to keep changes.

## Summary

- There are two views of Table: Design View and Datasheet View.
- Using the datasheet view, you can add, modify, search or delete records.
- You can hide/column and freeze/unfreeze required column(s) of a table.
- The process of arranging all the records in a table either ascending or descending order based on field or fields is known as sorting.

## Exercise

### 1. Answer the following questions.

- Define datasheet with examples.
- Which view is used to modify a table in MS-Access?
- Mention the process to add records in a datasheet.
- Define freezing and unfreezing the column. How is it done?
- Explain data sorting. List any two advantages of using it.

**2. Tick (✓) the correct answer.**

- a) In a datasheet, what does each column represent?
  - i. Record            ii. Field            iii. Database        iv. Table
- b) In a datasheet, what does each row represent?
  - i. Record            ii. Field            iii. Database        iv. Table
- c) A table structure can be modified in .....
  - i. Datasheet view    ii. Wizard            iii. Design view    iv. None of them
- d) The process of arranging all the records in a table either ascending or descending order
  - i. Sorting            ii. Indexing            iii. Filtering            iv. All of them

**3. State whether the following statements are 'True' or 'False'.**

- a) We cannot change the structure of a table once it is made.
- b) We can enter the data using datasheet view.
- c) You cannot unhide the hidden columns in a table.
- d) Data can be modified in datasheet view.
- e) Field with Memo, Hyperlink and OLE Objects data types cannot be sorted.

## 2.4 Querying Database

### i. Query

Query is the question asked for the database. Information stored in any database becomes meaningful only when you will be able to retrieve the desired information. So, using the various types of queries you can retrieve the information that you desire with some specific purpose. So, query is an object of database that is used to view, retrieve, change and analyse records from a table or multiple linked tables based on specified condition.

Using a query, you can answer very specific questions about your data that would be difficult to answer by looking at table data directly. You can use queries to filter your data, to perform calculations with your data, and to summarize your data.

There are two main types of Query used in Access.

**Select Query** : This type of query serve data from the table as per the user's request without making any change in the underlying data.

**Action Query** : This type of query changes data in the source table. The examples of Action Query are Update Query, Delete Query and Append Query.

#### a) Select Query

Select query is simply used to select and display the relevant data from the database. You can select all or part of data from a single or multiple tables or existing queries and display in datasheet. You can also use a select query to group records and calculate sums, counts, averages, minimum, maximum and other types of totals.

#### Creating a Select Query

Follow the below steps to create a select query:

Step 1: Open the database file created in MS-Access.

Step 2: Click on Create tab.

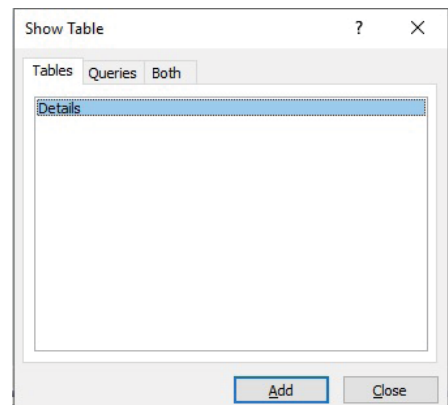



- Step 3: Click on Query Design button from Queries group. QBE (Query By Example) grid will appear. Also, a Show Table dialog box will appear with the list of tables and queries created in the database.
- Step 4: Select the required table based on which you are creating query. Click on Add.
- Step 5: Click on Close button.

## **QBE Grid**

The QBE grid appears with two sections. The upper section shows the list of fields in the selected table and the lower section shows the grid with rows and columns where we define the query.

The first row in the grid shows the fields that we have selected from the table.

The second row shows the table from which the field is selected.

The third row is 'Sort'. We can select 'Ascending', 'Descending' or 'Not sorted' for sort. If we set sorting option (ascending or descending) for more than one field then the leftmost field for which sorting is enabled becomes the primary sort key and other sorting enabled fields subsequently become the secondary sort keys.

Show row has check box for each field. The fields that are checked at this row are displayed and those not checked are not displayed.

The fifth row is 'Criteria'. Here, we can provide criteria or condition to select the records from the table.

The last row is 'or'. Here, we provide the criteria which are tested with OR logical operator with the above condition or criteria mentioned in the row 'Criteria'.

Now, do the following tasks in the QBE grid:

- Step 1: First you need to bring the required field of table in the grid. We can drag or double click each field to bring them in the grid. So, bring the required field of the selected table from the upper section of QBE.
- Step 2: Choose the fields and select either Ascending or Descending from the Sort

row, if you want to display the result in sorted order of any field.

Step 3: Remove the tick (√) mark from the checkbox of the Show row, if you don't want to show field(s).

Step 4: Set the criteria in Criteria row. In this example, "10" is written in the Class field and "A" is written in the Section field. It means only the records of Class 10A are selected in the query.

Field:	SID	SName	Class	Section	Roll
Table:	Details	Details	Details	Details	Details
Sort:		Ascending			
Show:	<input checked="" type="checkbox"/>	<input checked="" type="checkbox"/>	<input checked="" type="checkbox"/>	<input checked="" type="checkbox"/>	<input type="checkbox"/>
Criteria:			10	"A"	
or:					

## Running the Query

After making a query, you need to run. Follow the below steps to run a query:

Step 1: Click on the Design tab under Query Tools.

Step 2: Click on Run button from Results group. A new datasheet will be displayed based on the criteria and other settings we provided in the query.

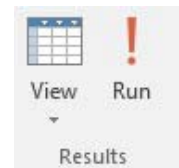

## Result of the above query

SID	SName	Class	Section	Roll
5	Rita Karn	10	B	5
7	Anish Magar	10	A	12
12	Rabin Thapa	10	A	20
13	Sushma Lama	10	B	34
21	Nisha Rai	10	B	17

*Details Table – Data source for the Query*

SID	SName	Class	Section
7	Anish Magar	10	A
12	Rabin Thapa	10	A

*Results*

## Calculation in Select Query

As mentioned earlier, select query can be used for mathematical calculation and display the result in new field. Let's explore the below example to understand how to perform this.

Step 1: Create a below table in MS-Access and named as “Marks”

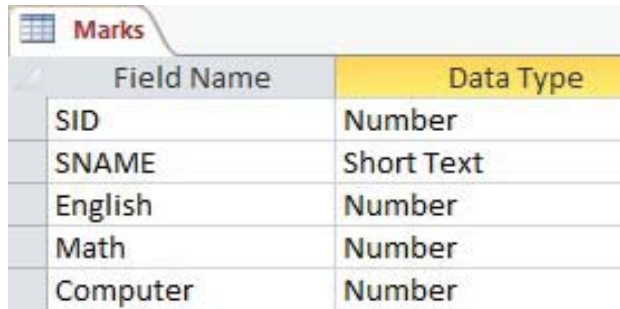

The screenshot shows the Datasheet View of a table named 'Marks'. The table has five columns: SID, SNAME, English, Math, and Computer. The data types for each column are: SID (Number), SNAME (Short Text), English (Number), Math (Number), and Computer (Number).

Field Name	Data Type
SID	Number
SNAME	Short Text
English	Number
Math	Number
Computer	Number

*Datasheet View – Table Marks*

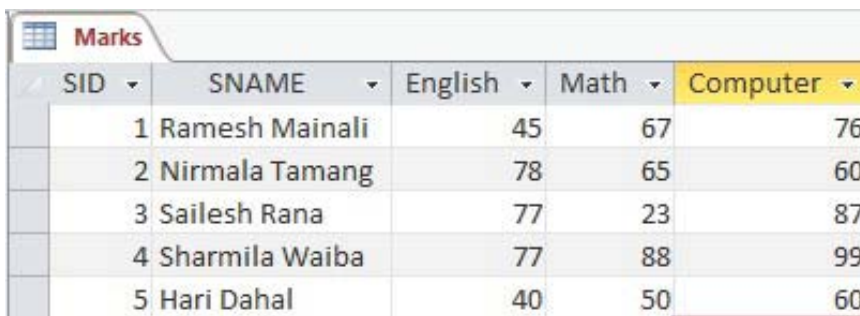

The screenshot shows the Design View of the 'Marks' table. The table has five columns: SID, SNAME, English, Math, and Computer. The data is as follows:

SID	SNAME	English	Math	Computer
1	Ramesh Mainali	45	67	76
2	Nirmala Tamang	78	65	60
3	Sailesh Rana	77	23	87
4	Sharmila Waiba	77	88	99
5	Hari Dahal	40	50	60

*Design View – Table Marks*

Step 2: To create a query, click on **Create** tab and click on **Query Design** button from Queries group.

Step 3: Select the table “**Marks**” from the **Show Table** dialog box. Click on Add and then Close.

Step 4: Bring all the fields of “**Marks**” in the **QBE** grid.

Step 5: In the QBE grid, type a new field name “Total” next to the field “Computer” and use the below expression to calculate Total marks.

**Total: [English] + [Math] + [Computer]**

Field:	SID	SNAME	SNAME	English	Math	Computer	Total: [English]+[M]
Table:	Marks	Marks	Marks	Marks	Marks	Marks	
Sort:							
Show:	<input checked="" type="checkbox"/>	<input checked="" type="checkbox"/>	<input checked="" type="checkbox"/>	<input checked="" type="checkbox"/>	<input checked="" type="checkbox"/>	<input checked="" type="checkbox"/>	<input checked="" type="checkbox"/>
Criteria:							

Step 6: Run the query. You will see the new column with calculated total marks.

SID	Expr1001	SNAME	English	Math	Computer	Total
1	Ramesh Mainali	Ramesh Mainali	45	67	76	188
2	Nirmala Tamang	Nirmala Tamang	78	65	60	203
3	Sailesh Rana	Sailesh Rana	77	23	87	187
4	Sharmila Waiba	Sharmila Waiba	77	88	99	264
5	Hari Dahal	Hari Dahal	40	50	60	150

## b) Action Query

An action query is a query that makes changes to or removes many records in just one operation. Here, we discuss only two types of action query. Below are the four different types of action queries.

### i) Update Query

An update query makes entire changes to a record or group of records in one or more tables. For example, you can increase the salary of all staff by 10% from a single operation in the staff database. With an update query, you can change data in existing tables.

Let's explore the below example to understand how to perform this.

Step 1: Create a below table in MS-Access and named as “Staff”

Field Name	Data Type	EID	EName	Post	Salary
EID	Short Text	1	Niraj K.C.	Accountant	\$5,000.00
EName	Short Text	2	Ashmita Giri	Manager	\$6,000.00
Post	Short Text	3	Rahul Sharma	Driver	\$2,000.00
Salary	Currency	4	Kunti Lama	Officer	\$3,000.00

*Design View – Table Staff*

*Datasheet View – Staff*

Step 2: To create a query, click on Create tab and click on Query Design button from Queries group.

Step 3: Select the table “Staff” from the Show Table dialog box. Click on Add and then Close.

Step 4: From the Design tab, select Update type from Query Type group.

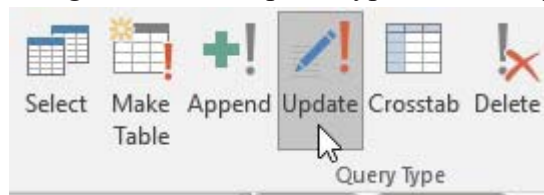

Step 5: As we are going to update the value of Salary field only, bring the field “Salary” of “Marks” in the QBE grid by double-clicking on it.

Step 6: Type the below expression in the “Update To” row:

**[Salary]\*1.1**

Step 7: **Run** the query.

Step 8: A message box will appear for your confirmation. Click on **Yes**. And see the below updated result in the table “Staff”.

Staff				Staff			
EID	EName	Post	Salary	EID	EName	Post	Salary
1	Niraj K.C.	Accountant	\$5,500.00	1	Niraj K.C.	Accountant	\$5,000.00
2	Ashmita Giri	Manager	\$6,600.00	2	Ashmita Giri	Manager	\$6,000.00
3	Rahul Sharma	Driver	\$2,200.00	3	Rahul Sharma	Driver	\$2,000.00
4	Kunti Lama	Officer	\$3,300.00	4	Kunti Lama	Officer	\$3,000.00

*Before Delete – Table Marks*                      *Before Update – Table Staff*

## ii) Delete Query

A delete query deletes a record or group of records from one or more tables. For example, you can delete the records of those students who have got marks less than 40 in each subject in the marks database.

Let’s explore the below example to understand how to perform this.

Step 1: Open the database file that has the table “Marks”

Step 2: To create a query, click on Create tab and click on Query Design button from Queries group.

Step 3: Select the table “Marks” from the Show Table dialog box. Click on Add and then Close.

Step 4: From the Design tab, select Delete type from Query Type group.



Step 5: You need to give criteria to select records in order to erase. In this example, we are erasing the records of those students who have got marks less than 40 in each subject. So, we have to apply condition in all the fields of subjects. Bring all the subject fields in the QBE grid by double-clicking on them.

Step 6: Provide condition in the Criteria row as in below figure.

Field:	English	Math	Computer
Table:	Marks	Marks	Marks
Delete:	Where	Where	Where
Criteria:	<40		
or:		<40	
			<40

**Note:** Here, the condition <40 for each subject is given in the different lines of criteria to use OR operator. If you write the condition in the same line of Criteria row, AND operator will be applied.

Step 7: A message box will appear for your confirmation. Click on Yes. And open the table to check whether the records are deleted or not.

SID	SNAME	English	Math	Computer
1	Ramesh Mainali	12	67	76
2	Nirmala Tamang	78	65	60
3	Sailesh Rana	77	23	87
4	Sharmila Waiba	77	88	99
5	Hari Dahal	40	50	60
*	0	0	0	0

*Before Delete – Table Marks*

SID	SNAME	English	Math	Computer
2	Nirmala Tamang	78	65	60
4	Sharmila Waiba	77	88	99
5	Hari Dahal	40	50	60

*After Delete – Table Marks*

### iii) Inserting records into table from queries

Using a query, you can insert record into a desired table. Let's explore the below example to learn how to insert new record using SQL statement.

SQL (Structured Query Language) is a language used to communicate with database. We can use several SQL statements to do different tasks with your database. Here, INSERT statement is used to insert record into a table.

Follow the below steps to insert a new record using INSERT SQL statement:

Step 1: Let's assume you have already created the below table "Marks". If not, create this table first where you are going to insert new record using query.

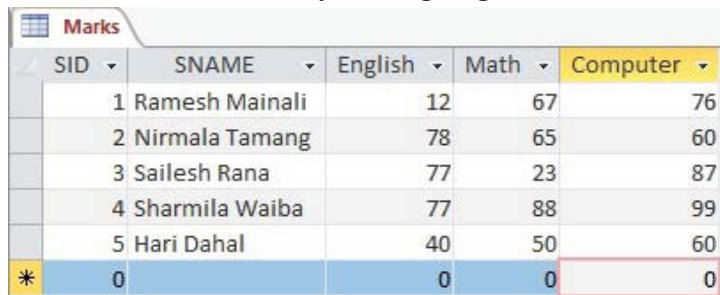

SID	SNAME	English	Math	Computer
1	Ramesh Mainali	12	67	76
2	Nirmala Tamang	78	65	60
3	Sailesh Rana	77	23	87
4	Sharmila Waiba	77	88	99
5	Hari Dahal	40	50	60
*	0	0	0	0

Step 2: Click Create tab and click Query Design from Queries Group.

Step 3: Close the Show Table window.

Step 4: From the Design tab, click on the SQL View button in Results group. A SQL View window will appear.

Step 5: Type the below INSERT statement in the SQL View window as below figure.

```
insert into Marks values (6,'Rabin Shahi',78,54,32) ;
```



*Table Marks*

**In the above INSERT statement,**

Marks – Name of the table

6,'Rabin Shahi',78,54,32 – Values for 5 fields (Text field value is enclosed within single quote 'Rabin Shahi')

Step 6: Run the query. A message will appear for your confirmation.

Step 7: Click Yes and open your table to see new records.

SID	SNAME	English	Math	Computer
1	Ramesh Mainali	12	67	76
2	Nirmala Tamang	78	65	60
3	Sailesh Rana	77	23	87
4	Sharmila Waiba	77	88	99
5	Hari Dahal	40	50	60
6	Rabin Shahi	78	54	32

In the above table, one new record is added.

### Wildcard Characters and Operators in Query

Wildcards/ Operators	Example	Description
?	?????UP	It represents a single character. ?????UP shows the records from the specified field that has first any five character before UP.
*/	S* / Like S*	Represents the number of characters. S* retrieves the record from the field that starts from the character S.
#		Represents any single digit, 0-9.
>	>100	Shows the record where the specified field is greater than 100.
<	<200	Shows the record where the specified field is less than 200.
>=	>=100	Shows the record where the specified field is greater than or equal to 100.
<=	<=200	Shows the record where the specified field is less than or equal to 200.
<>	<>50	Shows the record where the specified field is not equal to 50.
Between.... And	Between #02/04/10# And #04/07/12#	Shows the record between 02/04/10 to 04/07/12 date.



In	In("Ram", "Hari")	Shows the record that has the field value as Ram or Hari.
AND	>60 And <=80	Shows the record that has specific value from 61 to 80
OR	"Bus" OR "Car"	Shows the record that has specific value Bus or car.
Is Null		Shows the record that has no value.
IS not Null		Shows the record that has no null (blank) value.

## Summary

- Query is the question asked to database.
- There are two main types of Query used in Access: Select Query and Action Query.
- Select query is simply used to select and display the relevant data from the database.
- An action query is a query that makes changes to or removes many records in just one operation. Examples of action query are update query and delete query.

## Exercise

### 1. Answer the following questions.

- What is query? List the different types of query.
- What is the importance of Query in database?
- Differentiate between Select query and Action query.
- Lists the cases in which update query can be used.
- Explain the method of inserting new record into a table using query.

### 2. Tick the correct answer.

- The frame work for viewing records with some criteria in database is .....
  - Query
  - Form
  - Report
  - Table

- b) Which query do you use to answer the question “Which employees earn more than \$5000 a month”?
- i. Search query    ii. Append query    iii. Select query    iv. Update query
- c) Which criteria in query return only those names beginning with the letter “S”?
- i. name = “S”    ii. name = “S\*”    iii. name = “S?”    iv. name = “S#”
- d) ..... query is used to display the relevant data from the database without making any changes.
- i. Select            ii. Parameter    iii. Crosstab    iv. Append
- e) A(n) ..... query makes entire changes to a record or group of records in one or more tables
- i. Select            ii. Make Table    iii. Update        iv. Append

**3. State whether the following statement are 'True' or 'False'.**

- a) A query is used to select fields and records from one or more tables.
- b) A query can be created without tables.
- c) You can select all or part of data from a single or multiple linked tables using query.
- d) Update query can even make changes to the auto number field.

## 2.5 Creating and Using Forms

### Forms

Form is one of the MS-Access database objects that is primarily used to create an interface for entering data in a table or multiple linked tables. Forms are basically GUI (Graphical Users Interface) using which users interact with MS-Access database. Form also displays complete record one at a time, so you can view and modify records using the form.

### Creating form by using the wizard

The wizard enables you to select the fields from a table or multiple linked tables, layout, and user interface for the form. Follow the below steps to create forms using the wizard option:

- Step 1: Open the **Access** database file.
- Step 2: Click on **Create** tab.
- Step 3: Click on **Form Wizard** button from **Forms** group. **Form Wizard** dialog box will appear.
- Step 4: Choose the required table from the Tables/Queries drop-down list.

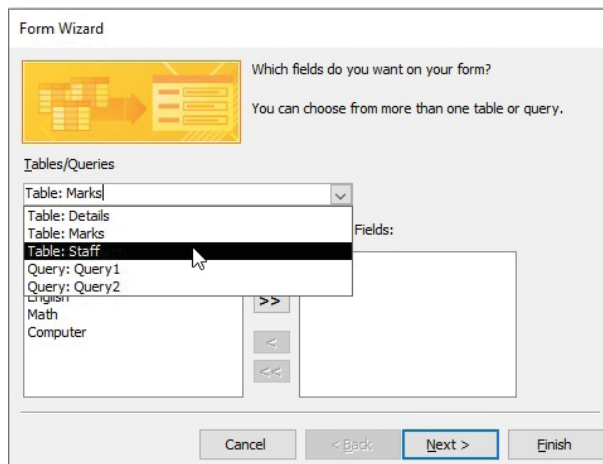
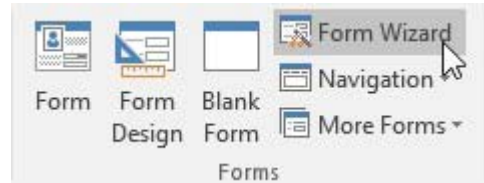

- Step 5: A list of fields of the selected table will be displayed. Now, you have to select the fields that you want to keep in the form from the Available Fields box. To select fields as per the requirement, click on single arrow  button to select

a single field or you can also select all the available fields at once by clicking on double arrow **>>** button. After selecting fields click on Next button.

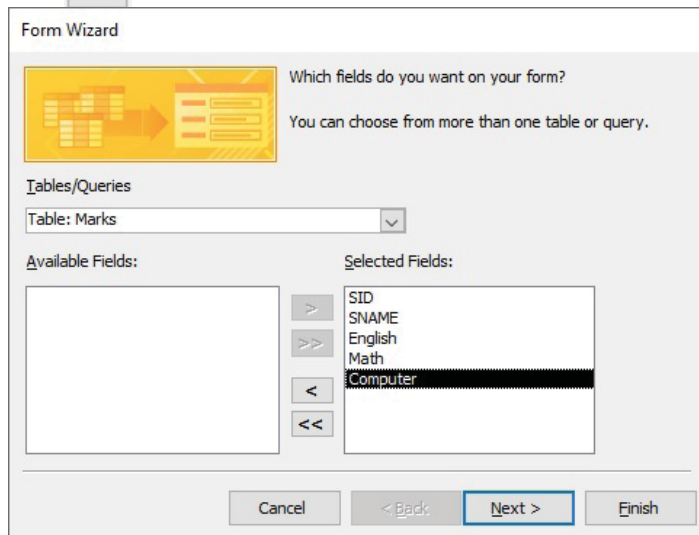

Step 6: Select the desired layout. In this example, Columnar is chosen. Click Next.

Step 7: Type the title of the form. In this example, Marks\_Forms is typed.

Step 8: Click on Finish button.

Now, the form for the Marks table is created as below:

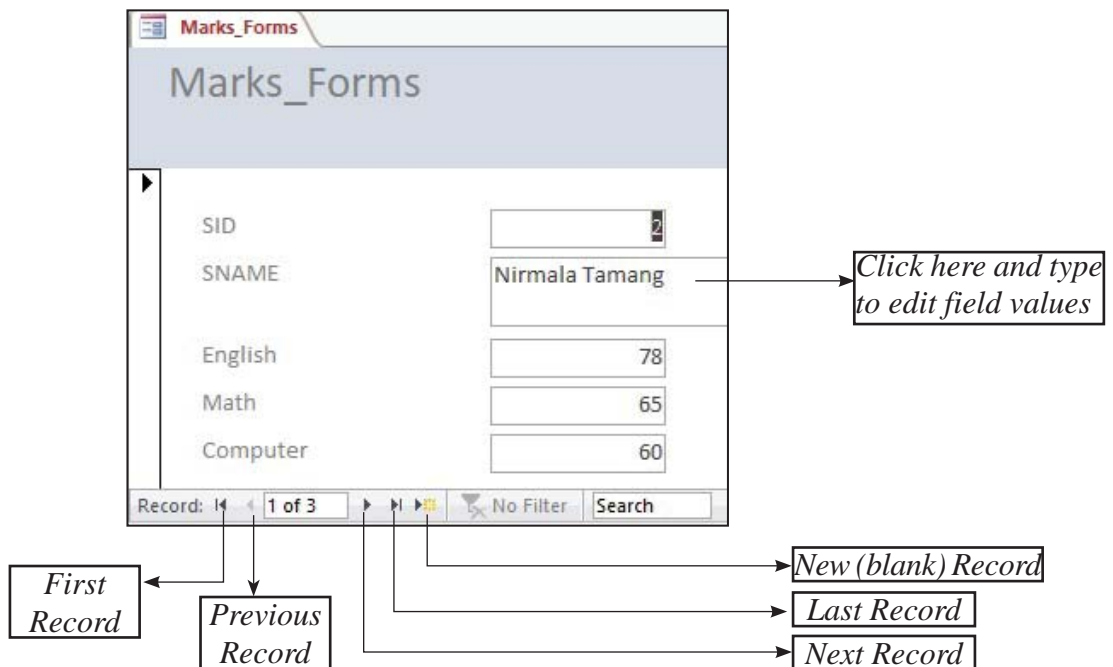

## Entering Data Using a Form

After the form is created, you can enter the data simply typing in the text box. MS-Access form also contains the various control options while entering the data. These control options are, Text box, Combo box, List box, Check box, Label, Command button, Tab control, Image, hyperlink etc. Steps to add records in form datasheet are as follows:

- After you open form datasheet, mouse cursor will be placed in the first field of first record. Type the required data in the field.
- Press **Tab** or enter to move to the next field. Or, simply place the mouse cursor in the desired field.
- When you finish entering the all the data for the first record, MS-Access automatically prompts for entering the second record and so on.

### Summary

- Form is one of the MS-Access database objects used to view, modify and add records.
- The Form Wizard enables you to select the fields from a table or multiple linked tables, layout, and user interface for the form.

### Exercise

- 1. Answer the following questions.**
  - a) What is form? Mention its uses.
  - b) Explain the process to create form using wizard.
  - c) Why form is required in MS-Access?
- 2. State whether the following statements are 'True' or 'False'.**
  - a) The frame work for entering records in database is form.
  - b) Forms can be used to enter, retrieve, and display information
  - c) Forms can be created without table or query.
  - d) Data changed using form gets changed into a table.
  - e) User interface of the form can be changed as per user's choice.

## 2.6 Creating and Printing Reports

### Report

Report is one of the MS-Access database objects used to present information in an effective and organized format that is ready for printing. Using the report, you can display the information the way you want to view it. A report's record source refers to the fields in the underlying tables and queries. A report need not contain all the fields from each of the tables or queries that it is based on. Creating a report is very similar to creating a form.

### Creating Report by using Wizard

The wizard enables you to create a report in a desired format. The Report Wizard provides you with more flexibility such as you can choose the tables and fields, group the data, sort the data, summarize the data, choose a layout and orientation, apply a style, and title your report.

Follow the below steps to create a report using Wizard:

Step 1: Open the Access database file.

Step 2: Click on Create tab.

Step 3: Click on Report Wizard button from Reports group. Report Wizard dialog box will appear.

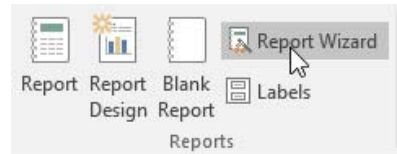

Step 4: Choose the required table from the Tables/Queries drop-down list.

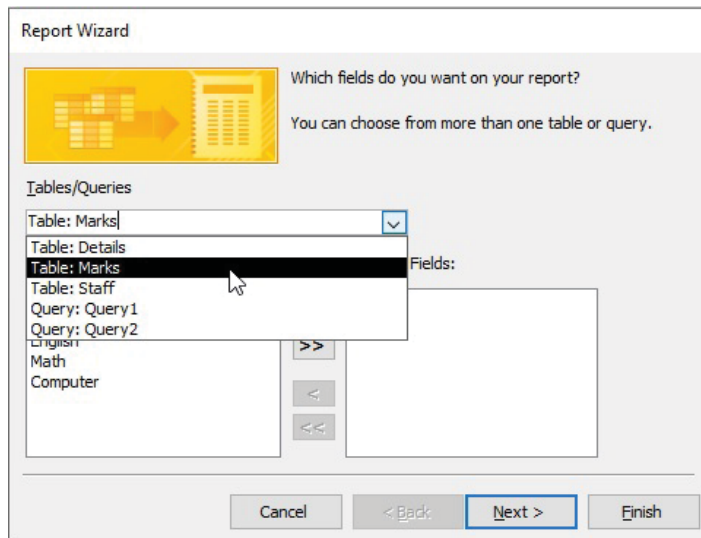

Step 5: A list of fields of the selected table will be displayed. Now, you have to select the fields that you want to keep in the form from the Available Fields box. To select fields as per the requirement, click on single arrow **>** button to select a single field or you can also select all the available fields at once by clicking on double arrow **>>** button. After selecting fields click on Next button

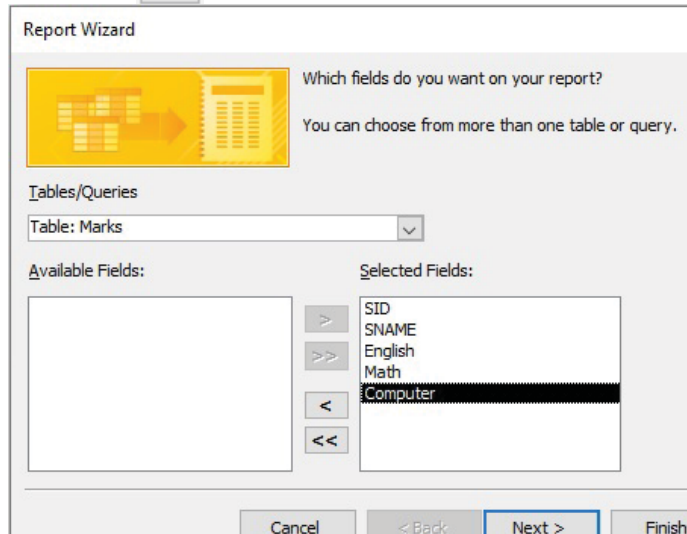

Step 6: On the next wizard screen, you can further group records in the report by a particular field. To group by a field, click the field and then click the arrow button. You can select several grouping levels in the order you want them. Then click Next to move on.

Step 7: The wizard then asks whether you would like to sort the records in the report as in the below figure. If you want to sort the records by a particular field or fields, open the top drop-down list and select a field by which to sort. Click Next to move on.

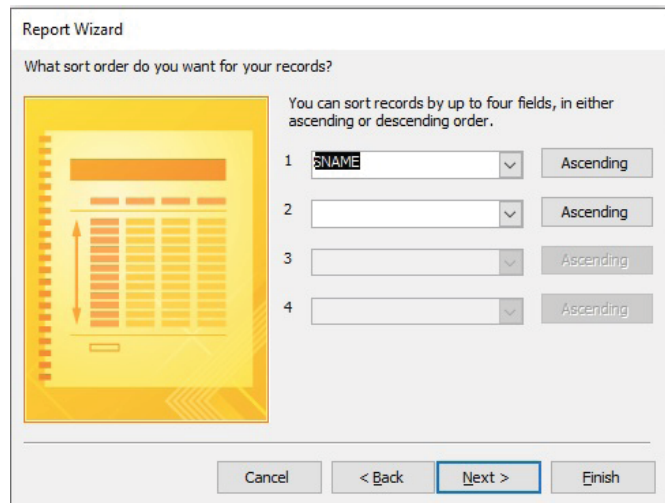

Step 8: On the next wizard, select the required Layout and Page Orientation. Click Next.

Step 9: Type the title of the report. In this example, Marks\_Report is typed.

Step 10: Click on the Finish button.

Now, the Report for the Marks table is created as below:

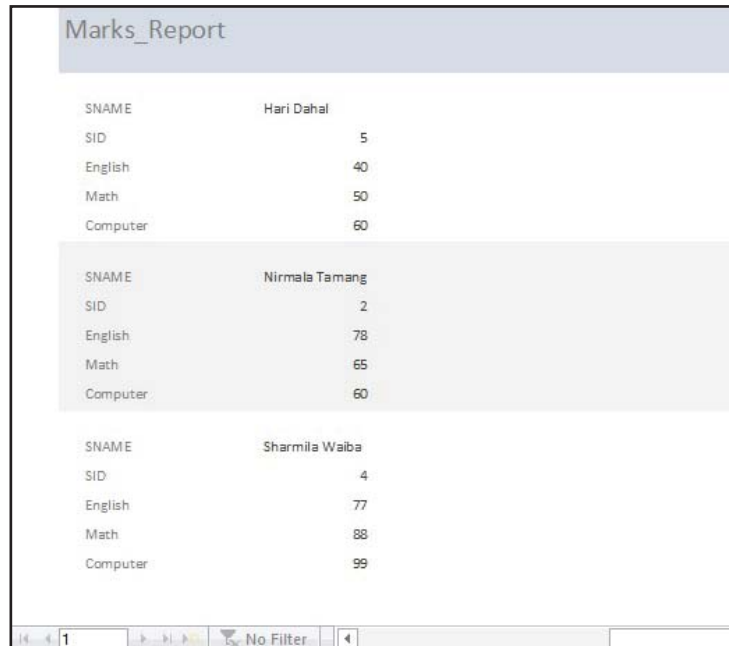

Marks_Report	
SNAME	Hari Dahal
SID	5
English	40
Math	50
Computer	60
SNAME	Nirmala Tamang
SID	2
English	78
Math	65
Computer	60
SNAME	Sharmila Waiba
SID	4
English	77
Math	88
Computer	99

## Viewing and Printing Reports in Print Preview

When you create a report with Report Wizard option, the report appears in Print Preview (as shown in above figure). From there, you can print the report if it is ok or go to Report Design view to make changes. In the

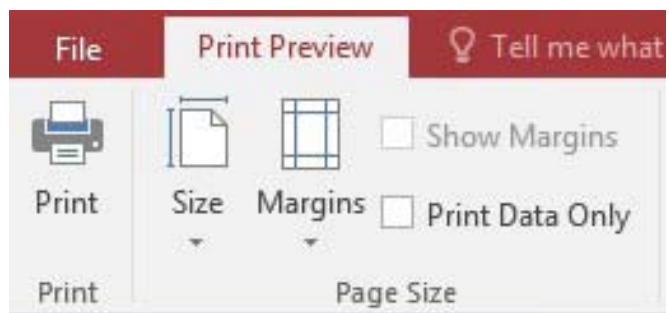

In the Print Preview mode, you can zoom in and out on the report using the Zoom tool (click once to zoom in and click again to zoom out). Using the appropriate button on the Print Preview toolbar, you can also display the report as one page, two pages, or multiple pages.



## Summary of the chapter

- Report is one of the MS-Access database objects used to present information in an effective and organized format that is ready for printing.
- The Report Wizard provides you with more flexibility such as you can choose the tables and fields, group the data, sort the data, summarize the data, choose a layout and orientation, apply a style, and title your report.

## Exercises

### 1. Answer the following questions.

- What is the report?
- What types of work is done in MS-Access using Form and query object?
- Mention the importance of creating report in database.
- List any two major differences between forms and reports.

### 2. Match the following

#### a. Group A

- a) Table
- Form
- Query
- Report

#### Group B

- i. Graphical interface for data entry
- ii. Search and select
- iii. Output in user's desired format
- iv. Primary database object
- v. Formatting records

#### b. Group A

- Show final information
- Data entry
- Create table structure
- Each column in a table

#### Group B

- i. Table
- ii. Design view
- iii. Field
- iv. Form
- v. Report

**3. State whether the following statements are 'True' or 'False'.**

- a) The frame work for viewing desired information in a specific format in database is report.
- b) Reports can be used to enter, retrieve, and display information
- c) Reports are only created with table.
- d) A report can be used to modify data of a table.
- e) Reports are the methods of retrieving information in meaningful way.

**4. In the LAB (Practical Section)**

**1(a) Create a database named 'Student' and table named 'Marks' with the following structure:**

<b>Field Name</b>	<b>Data Type</b>
Roll_no	Number (Primary Key)
Name	Text
DOB	Date/Time
English	Number
Nepali	Number
Maths	Number

**1(b) Add any five records in the above table.**

**2(a) Create a table with the following structure and save it under suitable name.**

<b>Field Name</b>	<b>Data Type</b>
Roll	Number
Name	Text
DOB	Date/Time
Eng	Number
Nep	Number
Science	Number

**2(b) Create a form and add any 10 records using it.**

**3(a) Create a database named 'Employee' and table named 'Records' with the following structure:**

<b>Field Name</b>	<b>Data Type</b>
Name	Text
Post	Text
Salary	Number
DOB	Date/Time
Extra	Memo

**3(b) Add any five records in the above table.**

- c. Make a Query “Query1” that displays all the records whose post is “Manager”.
- d. Make a Query “Query2” that displays all the records whose salary is greater than 10000 and less than 50000.
- e. Make a Query “Query3” that increases the salary of every employee by 3000 in the table.

**4(a) Create a database named 'company' and table named "staff" with the following structure:**

<b>Field Name</b>	<b>Data Type</b>
ID	Auto number (PK)
Name	Text
Address	Text
DOB	Date/Time
Marital status	Yes/No
Salary	Number

- b. Create a form and add any 10 records using it.
- c. Prepare a query to display all the unmarried staff.
- d. Prepare a query to calculate the tax amount. Tax amount is 1% of salary
- e. Prepare an update query to increase Salary by 10% of all the staffs.

f. Prepare a report using wizard (use table staff in report).

5(a) Create a database with the following structure and save it under suitable name.

<b>Field Name</b>	<b>Data Type</b>
Roll	Number (PK)
Name	Text
DOB	Date/Time
ENG	Number
NEP	Number
Science	Number

b. Add any five records to the table.

c. Create a query to display name, ENG and NEP fields.

d. Increase marks of the subject Nepali (NEP) 5% of every student.

e. Prepare a report consisting of Roll, Name, DOB and Nepali Fields.

6(a) Create a table 'student' having following structure:

<b>Field Name</b>	<b>Data type</b>
ROLL	Number (Primary key)
NAME	Text
ADDRESS	Text
GENDER	Yes/No
DOB	Date

b. Add five records in the table.

c. Make a query 'Disp' to display all the records in ascending order by their Names.

d. Create a query to display all the records having the Roll No greater than 3.

e. Create a report including all the fields using wizard.

f. Delete all the male records using a delete query.

## Review of QBASIC Programming

### Introduction to QBASIC

QBASIC (Quick Beginner's All-purpose Symbolic Instruction Code) is a high-level programming language developed by Microsoft Corporation in 1985. It is a modular programming language, where program is divided into different modules or procedure. QBasic is simple and easy to learn. It uses English like keywords and mathematical symbols to write a program.

### Different Control Statements

#### Branching

- i) IF ... ELSEIF ... END IF statement
- ii) SELECT ... END SELECT statement

#### Looping

- i) FOR ... NEXT statement
- ii) DO ... LOOP statement
- iii) WHILE ... WEND statement

### Lab Activities

#### Program #1

*Program to display first 100 natural numbers:*

```
REM To display first 100 natural numbers
```

```
CLS
```

```
FOR i = 1 TO 100
```

```
    PRINT i;
```

```
NEXT i
```

```
END
```

Note: Re-write the above program using other looping statements.

## Program #2

*Program to display the multiplication table of any supplied number:*

```
REM To display the multiple tables of any supplied number
CLS
INPUT "Type any number "; n
c = 1
DO
    PRINT n; "x"; c; "="; n * c
    c = c + 1
LOOP WHILE c <= 10
END
```

Note: Re-write the above program using other looping statement.

## Program #3

Program to check prime or composite

REM TO check prime or composite

CLS

INPUT "Type any number "; n

FOR i = 2 TO n - 1

IF n MOD i = 0 THEN c = c + 1

NEXT i

IF c = 0 THEN

PRINT "Prime"

ELSE

PRINT "Composite"

END IF

END

## Program #4

*Program to check Armstrong or not:*

```
REM To check Armstrong or not
```

```
CLS
```

```
INPUT "Type any number "; n
```

```
a = n
```

```
WHILE n <> 0
```

```
    r = n MOD 10
```

```
    s = s + r ^ 3
```

```
    n = n \ 10
```

```
WEND
```

```
IF a = s THEN
```

```
    PRINT "Armstrong"
```

```
ELSE
```

```
    PRINT "Not Armstrong"
```

```
END IF
```

```
END
```

## B) Library Functions

a) LEN ()

b) LEFT\$ ()

c) RIGHT\$ ()

d) MID\$ ()

e) LCASE\$ ()

f) UCASE\$ ()

g) VAL ()

h) STR\$ ()

i) ASC()

j) CHR\$()

i) SQR ()

j) FIX()

k) INT()

l) LTRIM\$ ()

## Program #5

*Program to display the reverse of a string:*

```
REM To display the reverse of a supplied string
CLS
INPUT "Type any string "; s$
FOR i = 1 TO LEN(s$)
    b$ = MID$(s$, i, 1) + b$
NEXT i
PRINT "Reversed String = "; b$
END
```

## Program #6

*Program to count the number of vowels in a word:*

```
REM To count the number of vowels
CLS
INPUT "Type any string value "; A$
FOR i = 1 TO LEN (A$)
    B$ = UCASE$(MID$(A$, i, 1))
    SELECT CASE b$
        CASE "A", "E", "I", "O", "U"
            c = c + 1
    END SELECT
NEXT i
PRINT "Number of Vowels = "; c
END
```



### Program #7

*Program to check perfect square or not:*

REM To check perfect square or not

CLS

INPUT "Type a number "; n

a = SQR (n)

IF a = INT (a) THEN

    PRINT "Perfect Square"

ELSE

    PRINT "Not Perfect Square"

END IF

END

### Program #8

*Program to display only composite numbers between 10 and 100:*

REM To display only composite numbers between 10 and 100

CLS

FOR a = 10 TO 100

    c = 0

    FOR b = 2 TO a - 1

        IF a MOD b = 0 THEN c = c + 1

    NEXT b

    IF c > 0 THEN PRINT a;

NEXT a

END

## Exercise

### 1. Write the below programs in QBASIC:

- a) Write a program that asks any number and checks whether it is divisible by 3 or not.
- b) Write a program that accepts an alphabet and tells whether it is a vowel or a consonant.
- c) Write a program that asks student's roll numbers and tells him/her room number where he/she has to sit to give the exam as below the criteria

Roll No.	Room No.
1-10	5
11-20	6
22,25,29,31	7
Above 35	8
Others	9

- d) Write a program that asks your name and displays it 10 times.
- e) Write a program to display the first 100 natural numbers with their sum.
- f) Write a program to generate the following series:
  - i) 1,4,7, ..., up to 10th terms
  - ii) 100,95,90,85,.....,5
  - iii) 1,2,4,8,16,....., up to 10th terms
  - iv) 1,2,4,7,11,16,22, ... , up to 10th terms
  - v) 1,4,9,16,...., up to 10th terms
  - vi) 1,8,27,64,...., up to 10th terms
  - vii) 999,728,511,342,...., up to 10th terms
  - viii) 1,11,111,1111,1111
  - ix) 1,2,3,5,8,13,21,...., up to 10th terms
- g) Write a program that checks whether the supplied number is palindrome or not. [Note: Example of palindrome number is 424]

- h) Write a program that asks any binary number and calculates its decimal equivalent.
- i) Write a program that asks any number and displays its factors.
- j) Write a program that asks any number and calculates its factorial. [Hint: Factorial of 5 =  $5 \times 4 \times 3 \times 2 \times 1$  i.e. 120]
- k) Write a program that checks whether the supplied character is capital alphabet, small alphabet, numeric character or other symbol.
- l) Write a program that checks whether the supplied string is palindrome or not. [A string is a palindrome if it is same when spelt from reverse order also. Eg. MADAM]

# Modular Programming

---

## Introduction

Modular programming is a technique used to divide our program into many small logical, manageable and functional modules or blocks. Every modular program has one main module and may have many sub modules. The module of a program is also called procedure.

## Advantages of Modular Programming

Some advantages of modular programming are:

- Many programmers can write different program modules independently.
- The debugging of the program becomes easier and faster.
- The same procedure can be used in different places, which reduces the program codes.
- It improves the readability of a program.
- It is easy to design code.

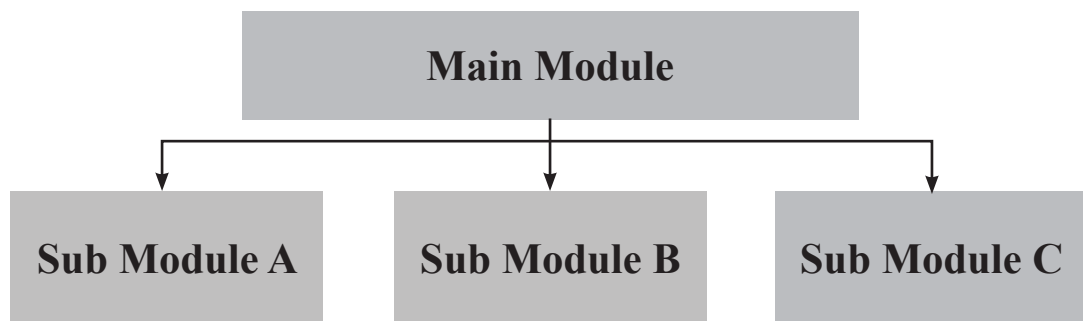

## Modular Programming in QBASIC

We can handle modular programming in QBASIC by two ways:

- a) Sub-procedure
- b) Function-procedure

## Creating Sub-procedure

### Sub-procedure

A sub-procedure is a small manageable and functional part of a program that performs specific tasks and does not return any value to the calling module. A sub procedure is needed to define before it is used in a program. A **CALL** statement is used to call the sub procedure in a program.

A sub program is written with **SUB.....END SUB** statement.

There are two parts of sub-program in QBASIC:

- a) Declaration Part
- b) Definition Part

### Declaration Part of Sub-Procedure

To create a sub-program in QBASIC, we need to declare at first. We use **DECLARE** statement for this purpose.

### DECLARE statement

Purpose: a non-executable statement that declares references to QBASIC sub-program

### Syntax:

**DECLARE SUB <name> [(<Parameter List>)]**

- name is the name of the sub-program (sub-procedure or procedure) that will be used to call the procedure
- parameter list indicates the number and type of arguments that will be used to call the procedure

### Example:

**DECLARE SUB Sum (A, B)**

In the above example, Sum is the name of the procedure whereas A and B indicates the parameter list.

### Definition part of Sub-Program

The second step of creating a sub-program is to include the statement associated with

its tasks. We use **SUB....END SUB** statement to define a sub-program.

### **SUB...END SUB statement**

Purpose: a procedure statement that marks the beginning and end of a subprogram

#### **Syntax:**

```
SUB <name> [(parameter List)]  
    <body (codes)>  
    .....
```

#### **END SUB**

#### **Example:**

```
SUB Sum (P, Q)  
    c = P + Q  
    PRINT "Sum = "; c  
END SUB
```

- While defining a sub-procedure, press Enter key after typing Sub <name> (Parameter List).
- A new window will appear which is called a sub-module or a sub-procedure. The body of sub-program is written between SUB... END SUB of this window.

#### **To switch between the windows:**

You can move either from sub-module to main-module or from main-module to sub-module by pressing SHIFT+F2 keys at the same time.

or

You can press only F2 key to display the list of procedures along with main-module. You can choose the required name of procedure from this list to switch into it.

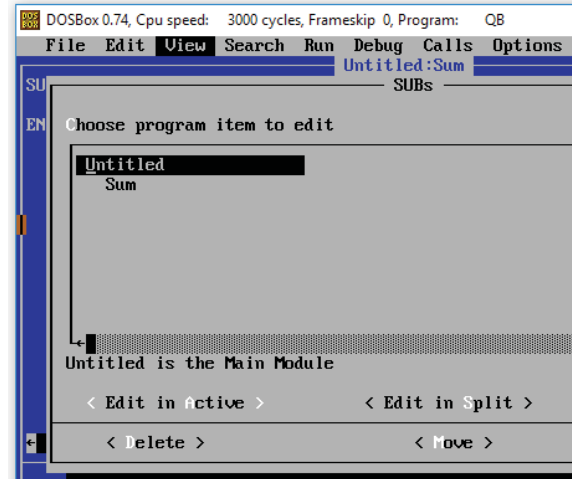
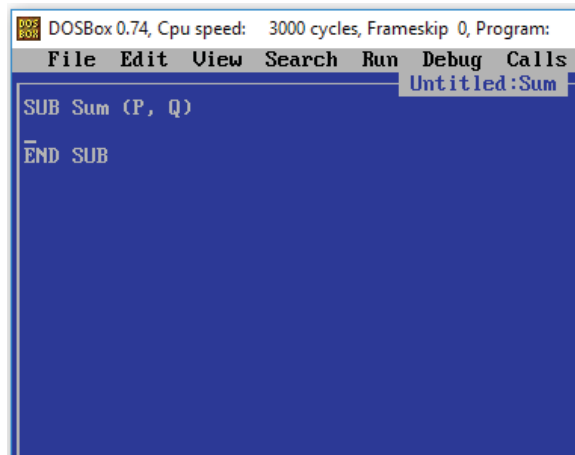

## Executing sub-programs

To run a sub-program, you need to use CALL statement in the main-module.

### CALL statement

Purpose: a statement that transfers control to another sub procedure from main module.

#### Syntax:

**CALL <name> [(<argument list>)]**

- name is the name of the SUB
- argument list lists the variables or constants passed to the SUB

#### Example:

CALL Sum (P, Q)

Let's see the whole program now:

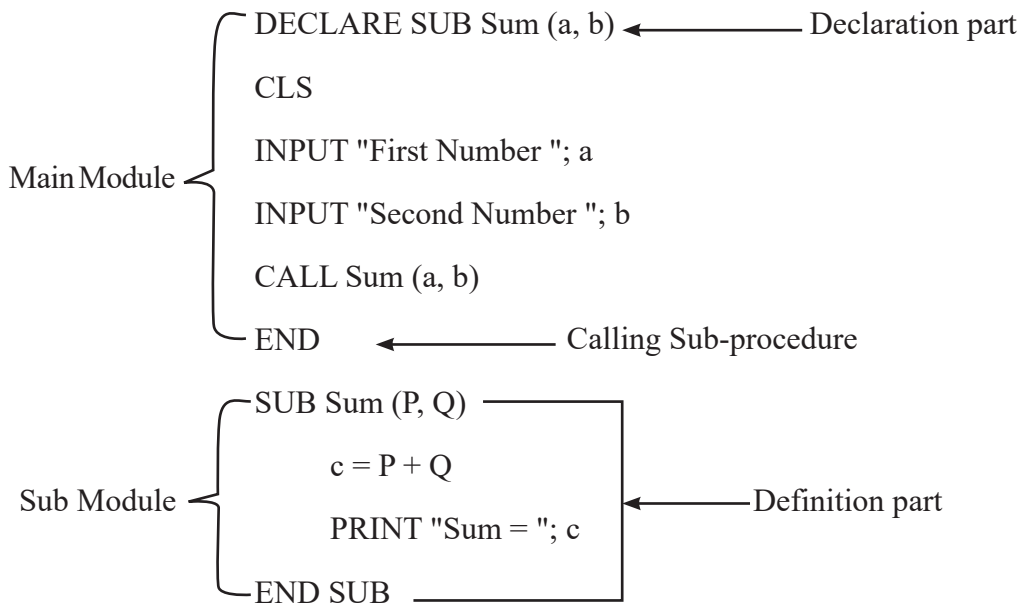

#### Output:

Type First Numer ? 45

Type Second Number ? 6

## Call by Reference and Call by Value

### Call by Reference

Call by reference is a method of calling a procedure in which the reference (address) of parameters are passed to the calling procedure module instead of actual value. By default, the parameters are passed using call by reference method.

#### Example:

```
DECLARE SUB test (p, q)
```

```
CLS
```

```
p = 10
```

```
q = 5
```

```
CALL test (p, q)
```

```
PRINT p, q
```

```
END
```

```
=====
```

```
SUB test (a, b)
```

```
a = a + 5
```

```
b = b + 5
```

```
END SUB
```

#### Output:

```
15  10
```

In the above program, while calling the sub-program **test**, the parameter **p** and **q** are passed to the sub procedure **test** using call by reference method. In the sub module, reference/address of **p** and **q** are passed to sub module and stored in the local variable **a** and **b** respectively. When the value of '**a**' is increased by **5**, the change occurs in the variable '**p**' of main module. In the same way, the value of '**q**' of main module is also increased by **5**.

So, the values of '**p and q**' are increased by **5** and the output is **15 10**.



## Call by value

Call by value is a method of calling a procedure in which actual data are passed to the calling procedure module. It is done by enclosing each parameter by a separate parenthesis ( ).

### Example:

```
DECLARE SUB display (n)

CLS

n = 5

CALL display ((n))

PRINT n;

END

=====

SUB display (p)

p = p + 5

END SUB
```

In the above program, while calling the sub-program **display**, the parameter '**n**' is passed to the sub procedure display using call by value method. In the sub module, value of '**n**' is passed to sub module and stored in the local variable '**p**'. When the value of '**p**' is increased by 5, the change occurs in the variable '**p**' of sub module as '**p**' does not contain the reference of '**n**'.

So, the value of '**n**' is not increased by **5** and the output is: **5**

### Formal and Actual Parameter

Formal parameters are variables which are used to specify or declare types of data to be passed to the procedures either sub or function. A formal parameter is always variable(s).

Actual or Real parameters are arguments which are used to pass real value or data to the procedure. Actual parameters may be variables or constant values. An actual parameter

can also be in the form of expression.

**Example:**

```
DECLARE SUB SUM (A, B)
M=10
N=20
CALL SUM (M, N)
END
```

=====

```
SUB SUM (P, D)
    S=P+D
    PRINT "Sum of Two numbers"; S
END SUB
```

**In this example,**  
M and N are actual parameters or Arguments  
A, P, B and D are formal parameters

**Local variable and Global variable**

A variable which is defined in a module and is not accessible to any other modules is known as local variable. It is only accessible to the module where it is defined. Value of local variable is destroyed when execution of module is over.

**Example:**

```
DECLARE SUB test ()
CLS
a = 10
CALL test
END
```

=====

```
SUB test
    PRINT a
END SUB
```

**Output:**  
0  
The variable 'a' used in this program is a local variable and declared in main module. So, its scope is limited to main module only. It is not recognized in sub-module. That's why the statement PRINT a statement displays 0 on the screen.

A variable in main module which can be accessed from any module or procedure of a program is known as a global variable. Variable can be made global declaring them with **DIM SHARED** or **COMMON SHARED** or **SHARED** attribute.

### **Declaring global variable in Main module:**

**COMMON SHARED** and **DIM SHARED** statements are used to declare global variables in main module.

#### **a) COMMON SHARED Statement**

##### **Syntax:**

COMMON SHARED variable list

*variable list* is a group a one or more variables separated by a comma.

##### **Example:**

COMMON SHARED a, b, c

#### **b) DIM SHARED Statement**

##### **Syntax:**

DIM SHARED variable list

*variable list* is a group a one or more variables separated by a comma.

##### **Example:**

DIM SHARED a, b, c

### **Declaring global variable in Sub-module:**

**SHARED** statement is used to declare global variables in sub-module.

#### **a) SHARED statement**

##### **Syntax:**

SHARED variable list

*variable list* is a group a one or more variables separated by a comma.

##### **Example:**

SHARED a, b, c

### Example #1

```
DECLARE SUB test ()  
  
COMMON SHARED a  
  
CLS  
  
a = 10  
  
CALL test  
  
END  
  
=====
```

```
SUB test  
  
PRINT a  
  
END SUB
```

Output:

10

In this program, the variable 'a' is declared as global in main module using COMMON SHARED statement. So, it is recognized in sub-module also. Therefore, the statement PRINT a gives 10 on the output screen.

### Example #2

```
DECLARE SUB test ()  
  
CLS  
  
CALL test  
  
PRINT M  
  
END  
  
=====
```

```
SUB test  
  
SHARED M  
  
M = 5  
  
END SUB
```

Output:

5

In this program, the variable 'M' is declared as global in sub module using SHARED statement. So, it is recognized in main-module also Therefore, the statement PRINT M gives 5 on the output screen.

Now, let's practice some program using sub-procedure in computer lab.

### Example #1

```
REM to calculate area of a circle
DECLARE SUB area (r)
CLS
INPUT "Type radius "; r
CALL area(r)
END
=====
SUB area (r)
a = 22 / 7 * r ^ 2
PRINT "Area = "; a
END SUB
```

#### Note

Unlike Function procedure, Sub-Procedure does not return any value. So, we do not give any symbol after the sub-procedure while declaring and defining it.

### Example #2

```
REM To display multiple table
DECLARE SUB MT (n)
CLS
INPUT "Type a number "; n
CALL MT(n)
END
=====
SUB MT (a)
FOR i = 1 TO 10
    PRINT a; "x"; i; "="; a * i
NEXT i
END SUB
```

#### Note

Sub-Procedure does not return any value. So, we can use PRINT statement inside sub-procedure.

**Example #3**

```
REM To check odd or even
DECLARE SUB check (n)
CLS
INPUT "Type any number "; p
CALL check(p)
END
=====
SUB check (w)
IF w MOD 2 = 0 THEN
    PRINT "Even"
ELSE
    PRINT "Odd"
END IF
END SUB
```

**Note**

We can use different parameter names in declare, call and sub statement. But the number of parameters and their types must be same.

**Example #4**

```
REM To display first 10 natural numbers
DECLARE SUB series ()
CLS
CALL series
END
=====
SUB series
FOR i = 1 TO 10
    PRINT i;
NEXT i
END SUB
```

**Note**

This sub-procedure is created without parameter. If we don't need to pass any values to sub-module from main-module, we can leave blank in the place of parameter list.

### Example #5

REM To check palindrome word or not

```
DECLARE SUB check (k$)
```

```
CLS
```

```
INPUT "Type a string "; s$
```

```
CALL check(s$)
```

```
END
```

```
=====
```

```
SUB check (n$)
```

```
FOR i = 1 TO LEN(n$)
```

```
    b$ = MID$(n$, i, 1) + b$
```

```
NEXT i
```

```
IF n$ = b$ THEN
```

```
    PRINT "It is palindrome"
```

```
ELSE
```

```
    PRINT "It is not palindrome"
```

```
END IF
```

```
END SUB
```

### Note

Formal Parameter – n\$, k\$

Actual Parameter jf argument – s\$

### Example #6

REM To calculate area and volume

```
DECLARE SUB calc (l, b, h)
```

```
CLS
```

```
INPUT "Type length of a room "; l
```

```
INPUT "Type breadth of a room "; b
```

```
INPUT "Type height of a room "; h
```

```
CALL calc(l, b, h)
```

```
END
```

```
=====
SUB calc (l, b, h)
a = l * b
v = l * b * h
    PRINT "Area = "; a
    PRINT "Volume = "; v
END SUB
```

Note
Sub-Procedure does not return any value. So, we can define a sub-procedure for multiple output. It can perform more than one calculations.

## b) Creating Function Procedure

### Function-procedure

There are many functions including LEN(), MID\$(), ASC() etc. available in QBASIC as library function. But they are not sufficient for programmers. So, in some cases, we have to make such function ourselves. This type of function is called user-defined function because it is created by the user.

A user-defined function is written with FUNCTION ... END FUNCTION statement.

### Declaration part

#### DECLARE statement

**Purpose:** a non-executable statement that declares references to QBASIC user-defined function

#### Syntax:

**DECLARE FUNCTION <name> [(<Parameter List>)]**

- name is the name of the function that will be used to call the function
- parameter list indicates the number and type of arguments that will be used to call the function.

**Note:** DECLARE statement cannot be used after any executable statements. The same DECALRE statement for function procedure is used to declare sub-program

#### Example:

```
DECLARE FUNCTION Area (L, B)
```



## Definition part

FUNCTION...END FUNCTION statement

**Purpose:** a non-executable statement that defines the user-defined function

### Syntax:

```
FUNCTION <name> [(<Parameter list>)]
```

```
    <Body (Codes)>
```

```
    .....
```

```
    <name> =Expression
```

## END FUNCTION

- name, name of the function
- parameter list is one or more variables, separated by commas that will be passed to the function when it is called
- expression is the return value of the function

### Example:

```
FUNCTION Area (P, Q)
```

```
    A = P * Q
```

```
    Area = A
```

```
END FUNCTION
```

## Calling a User-Defined function

Since the function always returns a value, we can assign this value to another variable or print directly on the output screen. CALL statement cannot be used in user-defined function.

### Example:

```
c = Area(L, B)
```

```
PRINT "Area is "; c
```

or

```
PRINT "Area is "; Area(L, B)
```

**Let's see the whole program now:**

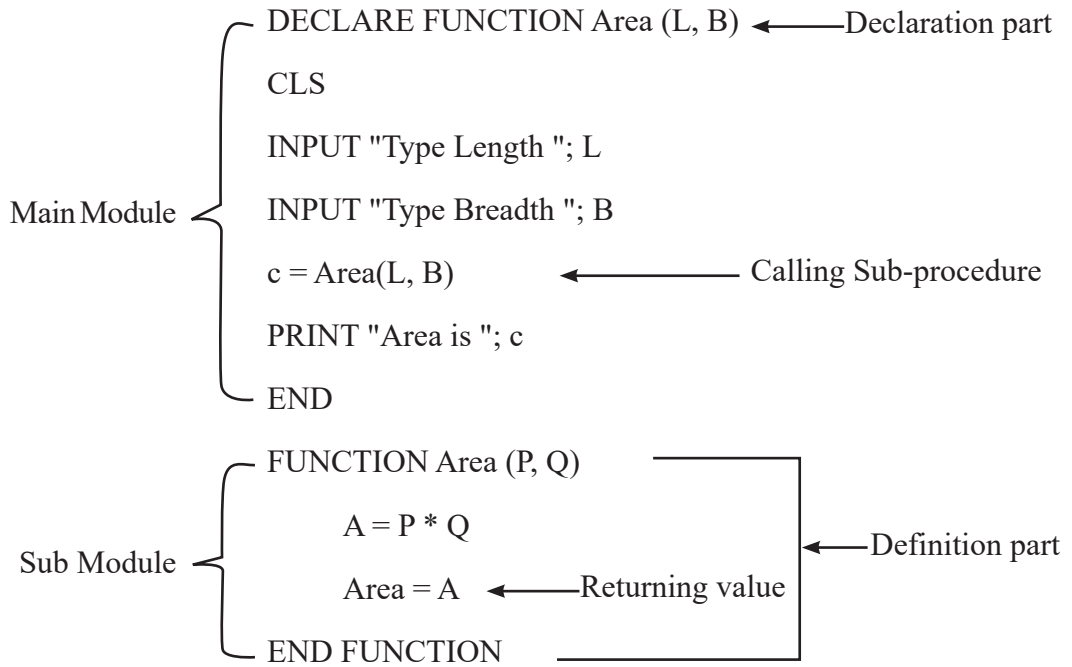

**Output:**

Type First Length ? 5

Type Breadth ? 3

Area is 15

Let's practice some program using function-procedure in computer lab.

### Example #1

```
REM To calculate Simple Interest
  DECLARE FUNCTION SI (a, b, c)
  CLS
  INPUT "Type Principal "; p
  INPUT "Type Time "; t
  INPUT "Type Rate "; r
  PRINT "Simple Interest = "; SI(p, t, r)
  END

=====

FUNCTION SI (p, t, r)
  i = (p * t * r) / 100
  SI = i
END FUNCTION
```

#### Note

The value returned by the function can be printed directly.

### Example #2

```
REM To calculate circumference
  DECLARE FUNCTION cir (r)
  CLS
  INPUT "Type radius of a circle "; r
  c = cir(r)
  PRINT "Circumference = "; c
  END

=====

FUNCTION cir (r)
  circum = 2 * 22 / 7 * r
  cir = circum
END FUNCTION
```

#### Note

The value returned by a function can be assigned to another variable.

### Example #3

```
REM To display the smaller number
  DECLARE FUNCTION small (a, b)
  CLS
  INPUT "Type any two numbers "; x, y
  PRINT "Smaller number is "; small(x, y)
  END

=====

FUNCTION small (a, b)
  IF a < b THEN
    small = a
  ELSE
    small = b
  END IF
END FUNCTION
```

#### Note

We can assign the value to be returned by the function anywhere inside the definition part of function-procedure.

### Example #4

```
REM To count vowels
  DECLARE FUNCTION vow (a$)
  CLS
  INPUT "Type any string "; s$
  PRINT "No. of Vowels = "; vow(s$)
  END

=====

FUNCTION vow (a$)
  FOR i = 1 TO LEN(a$)
    b$ = UCASE$(MID$(a$, i, 1))
    IF b$ = "A" OR b$ = "E" OR b$ = "I" OR
    b$ = "O" OR b$ = "U" THEN c = c + 1
  NEXT i
  vow = c
END FUNCTION
```

#### Note

There is no any symbol after the function name. So, the default return type of the function is Single Precision. The function returns Single Precision value.

### Example #5

```
REM sum of individual digits of an integer
DECLARE FUNCTION sum% (a%)
CLS
INPUT "Type an integer "; b%
PRINT "Sum of individual digit = "; sum%(b%)
END

=====

FUNCTION sum% (c%)
WHILE c% <> 0
    r% = c% MOD 10
    s% = s% + r%
    c% = c% \ 10
WEND
sum% = s%
END FUNCTION
```

#### Note

This function returns an integer value. Therefore, a % symbol is written after the function while declaring, calling and defining the function.

### Example #6

```
REM To display the reverse of a string
DECLARE FUNCTION rev$ (n$)
CLS
INPUT "Type any string "; s$
PRINT "Reverse is "; rev$(s$)
END

=====

FUNCTION rev$ (a$)
FOR i = 1 TO LEN(a$)
    b$ = MID$(a$, i, 1) + b$
NEXT i
rev$ = b$
END FUNCTION
```

#### Note

This function returns a string value. Therefore, a \$ (dollar sign) symbol is written after the function.

### Example #7

REM To calculate area and volume of a room

```
DECLARE FUNCTION area (l, b)
DECLARE FUNCTION vol (l, b, h)
CLS
    INPUT "Type length of a room "; l
    INPUT "Type breadth of a room "; b
    INPUT "Type height of a room "; h
    PRINT "Area = "; area(l, b)
    PRINT "Volume = "; vol(l, b, h)
END
=====
FUNCTION area (l, b)
    area = l * b
END FUNCTION
=====
FUNCTION vol (l, b, h)
    vol = l * b * h
END FUNCTION
```

#### Note

A function can return only one value. Therefore, two functions area and volume are created to calculate area and volume separately.

### Summary

- The process of writing a program in more than one module is called modular programming.
- We can handle modular programming in QBASIC in two ways: Sub-programs and User-Defined Function.
- SUB ---- END SUB statement is used to define a sub-procedure and CALL statement is used to use sub-procedure in main module.
- FUNCTION ---- END FUNCTION statement is used to define a user-defined

function.

- Function returns a value whereas Sub-procedure does not return any value.
- Function is used to perform only one calculation. Sub-procedure can be defined for multiple tasks.

## Glossary

---

Modular Programming	: Process of writing program in multiple modules
Main Module	: The main part of the program inside which several sub-modules are created
Sub-Program	: A group of statements written in a separate module to perform one or more tasks
Formal Parameter	: Parameter used while declaring and defining sub-program or user-defined functions
Actual Parameter	: Parameter used while calling sub-procedure or user-defined function
Local Variable	: The variable which is recognized only inside the module where it is declared
Global Variable	: The variable which can be accessed from all the modules

## Exercise

### 1. Answer the following questions.

- What is Modular Programming?
- What is Procedure? Mention its types.
- Write the difference between sub-procedure and function-procedure.
- Define main-module.
- Differentiate between local and global variable.
- Write anyone QBASIC program to show the difference between call by reference and call by value.

**2. Write the syntax and use of the following statements:**

- a) DECLARE statement
- b) FUNCTION ... END FUNCTION statement
- c) SUB ... END SUB statement
- d) CALL statement
- e) COMMON SHARED statement
- f) SHARED statement

**3. Write down the output of the below programs:**

**a) DECALRE SUB Series ()**

CALL Series

END

=====

SUB Series

X = 1

Y = 1

FOR Z = 1 TO 4

PRINT X;

Y = Y + 1

X=X\*10+Y

NEXT Z

END SUB

**b) DECLARE SUB result (A\$)**

A\$ = "education"

CALL Result (A\$)

END

=====

SUB Result (A\$)



```

For C = 1 To LEN (A$) STEP 2
    X$ = MID$ (A$, C, 1)
    PRINT X$
NEXT C
END SUB

```

**c) DECLARE SUB result (n\$)**

```

n$="SCIENCE"
CALL result (n$)
END

```

=====

```

SUB result (n$)
b= LEN (n$)
count = 1
WHILE count < =b
    x$ = x$ + MID$ (n$, count, 1)
    count = count + 2
WEND
PRINT x$
END SUB

```

**d) DECLARE SUB Series ( )**

```

CALL Series
END

```

=====

```

SUB Series
    A = 2
    B = 2
FOR ctr = 1 TO 2
PRINT A; B;

```

```
A = A + B
```

```
B = A + B
```

```
NEXT ctr
```

```
END SUB
```

e) **DECLARE SUB show (X)**

```
CLS
```

```
N = 87
```

```
CALL show (N)
```

```
END
```

```
=====
```

```
SUB show (A)
```

```
DO
```

```
    b = A MOD 6 + 3
```

```
    IF b MOD 4 = 0 THEN GOTO aa
```

```
    PRINT b;
```

```
aa:
```

```
    A = A - 10
```

```
LOOP WHILE A >= 50
```

```
END SUB
```

4. **Re-Write the below programs after correcting the bugs:**

a) **REM to display greater among 2 numbers**

```
DECLARE SUB great (p, q)
```

```
CLS
```

```
INPUT "Any two numbers "; a, b
```

```
DISPLAY great (p, q)
```

```
END
```

```
=====
```

```

SUB great (a, b)
IF a < b THEN
    PRINT a;
ELSE
    PRINT b;
END IF
END SUB

```

**b) REM to display the reverse of a string**

```

DECLARE SUB rev$ (n$)
CLS
INPUT "Any string "; s$
CALL rev$(s$)
END

```

```

=====

SUB rev$ (s$)
FOR i = 1 TO LEN(s$)
    b$ = MID$(s$, i, 1)
    r$ = r$ + b$
NEXT i
rev$ = r$
END SUB

```

**c) DECLARE SUB Fibonic( )**

```

REM *Fibonacci series*
CALL CUB Fibonic
END

```

```

=====

SUB Fibonic
    A = 1

```

```

    B = 1
FOR X= 1 TO 10
DISPLAY a;
    A = A + B
    B = A + B
END Fibonic

```

**d) DECLARE FUNCTION SUM (a, b)**

```

REM Program to sum given two numbers
INPUT "Enter first number; x
INPUT "Enter second number"; y.
PRINT SUM (a, b)
END

```

```

=====

```

```

FUNCTION SUM (x, y)
SUM = a + b
END

```

**e) CREATE FUNCTION Square (A)**

```

REM to print square of a number
CLS
GET "a number"; A
CALL Square (A)
END

```

```

=====

```

```

FUNCTION Square (A)
Ans = A ^ 2
Square = Ans
END Square (A)

```

**5. Study the following program and answer the given questions:**

**a) DECLARE FUNCTION XYZ (N)**

```
FOR I = 1 To 5
    READ N
    Z = xyz (N)
    S = S + Z
NEXT I
PRINT S
DATA 10, 13, 15, 4, 6
END
```

=====

```
FUNCTION xyz (N)
IF N MOD 2 = 0 THEN xyz = N
END FUNCTION
```

- i) What is the name of function used in the above program?
- ii) How many times will the function be called?

**b) DECLARE FUNCTION count (N\$)**

```
INPUT "Enter a word"; R$
C = count (R$)
PRINT C
END
FUNCTION count (N$)
FOR K = 1 TO LEN (N$)
X$ = MID$ (N$, K, 1)
IF UCASE$ (X$) = "A" Then
    X = X + 1
END IF
```

```
NEXT k
count = X
END FUNCTION
```

- i) List any two library functions used in the above program.
- ii) Write the use of variable 'C' in line 3[i.e.  $C = \text{Count}(R\$)$ ] given in the above program

**c) DECLARE SUB SUM (N)**

```
INPUT "ANY Numbers"; N
CALL SUM (N)
END
SUB SUM (N)
S = 0
WHILE N <> 0
    R = N MOD 10
    S = S + R
    N = N \ 10
WEND
PRINT "SUM"; S
END SUB
```

- i) In which condition will the statements within the WHILE....WEND looping statement not be executed?
- ii) Will the output be same if the place "\" instead of "/" in the above program?

**d) DECALRE FUNCTION Num (N)**

```
INPUT N
S=Num (N)
PRINT S
```

```
END
FUNCTION Num (N)
X=INT (17/N)
Y=15 MOD N
Num=X+Y
END FUNCTION
```

- i) Write the name of the function used in the above program?
- ii) List out the mathematical function (Library) used in the above program?

e) DECLARE Sub check ()

```
CLS
CALL check
END
SUB check
c$ = "APPLE"
c = 1
DO
    b$ = MID$(c$, c, 1)
    d$ = d$ + b$
c = c + 1
LOOP WHILE c <= 5
PRINT d$
END SUB
```

- i) What will be the output of the above program?  
a) ELPPA    b) Blank Screen    c) 0    d) None of them
- ii) What will be the output of the above program if the line LOOP WHILE c <= 5 is replace with LOOP UNTIL c >= 5?

### 1. Write QBASIC programs using sub-procedure:

- a) Write a program that asks any two numbers and find their difference using a sub-procedure.
- b) Write a program using SUB...END SUB that asks the temperature in Celsius and calculates its Fahrenheit equivalent. [Hint:[ $F=(9C)/5+32$ ]
- c) Write a sub program to display numbers -10, -5, 0, 5, 10, ..... up to 12th terms.
- d) Write a sub procedure program TRIANGLE( A, B, C) to input three angles of a triangle and determine whether a triangle is right angle triangle or not.
- e) Write a sub program to find smallest number among 3 different numbers.
- f) Write a sub program to check whether input number is prime number or not.
- g) Write a sub program to supply percentage from the keyboard and print grade. Use the following conditions to display the result.

Percentage	Grade
< 40	Fail
>= 40 to < 60	C
>= 60 to < 80	B
> = 80 to <= 100	A
> 100	Out of Range

- h) Create a sub procedure to display cube of the numbers between 1 to 50.
- i) Create a sub procedure program REVERSE (S\$) to display reverse of the input string.
- j) Write a sub program PALIN ( ) to check whether input number is palindrome or not using argument passing by value method.
- k) Write a program using SUB...END SUB to reverse an integer number input by a user.
- l) Write a sub program to convert decimal number into its equivalent binary number.



- m) Write a program to check whether the input number is negative, positive or zero using SUB ..... END SUB.
- n) Write a program to check whether the supplied number is perfect square or not using a sub procedure.
- o) Write a program to display only prime numbers between 1 and 500 using a sub procedure.

**2. Write QBASIC programs using function-procedure:**

- a) Write a program to find the area of four walls using a function procedure.
- b) Write a program to define a function procedure that returns simple interest.
- c) Write a program using a function procedure to check whether input number is even or odd.
- d) Write a program using a function procedure to calculate the square of all digits of input number.
- e) Create a user-defined function REV\$(S\$) to display reverse of the input string.
- f) Create user defined function SMALL (A, B, C) that accepts three different numbers and returns the smallest number.
- g) Write a program to check whether supplied number is perfect square number or not using FUNCTION ..... END FUNCTION.
- h) Write a program to create a function that returns the square of a supplied number.
- i) Write a function procedure COUNT (N) to count the number of digits in a number entered by the user.
- j) Write a user-defined function to check whether input number is Armstrong or not.
- k) Write a program to check whether the supplied number is prime or not using a function procedure.
- l) Write a program FACTOR (N) to display sum of factors of a supplied number using a function procedure.

# File Handling in QBASIC

---

## Introduction

The collection of different data or information or instructions, which is stored in secondary storage devices under a unique file name, is known as file. In QBASIC, two different files are used they are program files and data files.

File handling is a process to create a data file, write data to the data file and read data from the specified data file.

Data file is a collection of data such as name, address, class, etc. required for data processing.

Name	Address	Class	Section	Roll
Raju Sherpa	Jumla	10	A	15
Nira Chaudhary	Sarlahi	9	B	12
Rina Sharma	Kathmandu	10	B	19

The set of instruction written in a computer language for data processing under unique file name is known as program file.

QBASIC supports two types of file handling: Sequential and Random Access files handling.

Sequential Access to a data files means that the computer system reads or writes information to the file sequentially, starting from the beginning of the file and proceeding step by step. On the other hand, Random Access to a file means that the computer system can read or write information anywhere in the data file.

In this lesson, we will discuss sequential file handling.

## Basic File Operation

There are basically three file operations we can perform in QBASIC. They are:

- a) Opening the File
- b) Read from the File/Write into the File
- c) Close the File

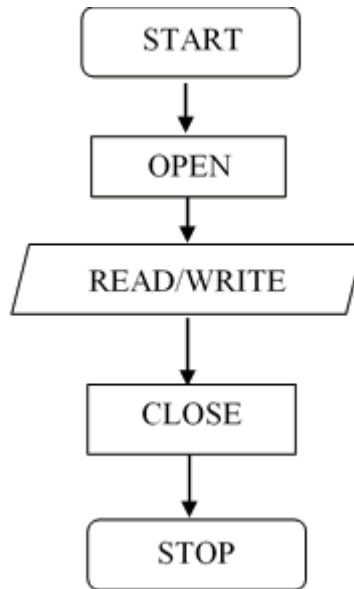

### a) Opening a file

While writing into the file or reading from file, first we need to open the file.

#### **OPEN statement**

Purpose: a file I/O statement that enables I/O to a file

#### **Syntax:**

#### **OPEN file [FOR mode] AS [#]filename**

- spelt is a string expression that specifies a file to be opened for writing or reading
- mode is one of the following keywords:
  - INPUT - Read only from sequential file
  - OUTPUT - Write to a sequential file
  - APPEND - Write to the end of a file
- filename is an integer expression whose value is between 1 and 255

The different modes of opening sequential data files are:

- i. Output mode                      ii. Input mode                      iii. Append mode

Mode	Purpose
Output or “O”	To create a new sequential data file and write data in it. It starts writing data always from the beginning of the file (BOF).
Input or “I”	To read / display data or information from the existing sequential data file.
Append or “A”	To add more records in the existing sequential file. It starts adding of data always from the end of the file (EOF).

Mode	If file exists	If file does not exists
Output or “O”	Creates a new file	Creates a new file
Input or “I”	Opens the existing file	Error Message "File not found"
Append or “A”	Opens the existing file	Creates a new file

**Example #1:**

**OPEN “STUDENT.DAT” FOR OUTPUT AS #1**

- It creates and opens a new file named “STUDENT.DAT” to store records.

**Example #2:**

**OPEN “D:\MARKS.DAT” FOR OUTPUT AS #2**

It creates and opens a new file “MARKS.DAT” in D: Drive to store records.

**Note:** When you open the file in OUTPUT mode which is already existed, your old file will be overwritten by the new one and the records in the old file is not accessible.

**Example #3:**

**OPEN “MARKS.DAT” FOR APPEND AS #1**

- It opens the existing file “MARKS.DAT” to add more records.

**Note:** When you open an existing file in APPEND mode, the same file will be opened. If the file does not exist, then it creates a new file as by OUTPUT mode.

#### Example #4

#### OPEN “STAFF.DAT” FOR INPUT AS #1

- It opens the existing file “STAFF.DAT” to read records from this file.

**Note:** The error message will be shown if the file does not exist.

#### Alternative Syntax of OPEN Statement

We can use OPEN Statement in alternative way as well.

**Syntax:** PEN <filemode>, #<file number >, <filename>

#### Example #5:

OPEN “O”, #1, “MARK.DAT” - *Opens the file in output mode.*

OPEN “I”, #1, “MARK.DAT” - *Opens the file in input mode.*

OPEN ”A”, #1, “MARK.DAT” - *Opens the file in append mode.*

#### b) Storing Records into a Data File

Follow the below steps to store records into a data file:

- i) Open the file in output mode for new file and open the file in append file if you want to add records in an existing file
- ii) Ask the data from the user

```
OPEN “ MARKS.DAT” FOR OUTPUT AS #1
```

```
INPUT “NAME”, N$
```

```
INPUT “ADDRESS”, A$
```

```
INPUT “ENGLISH”, E
```

```
INPUT “MATH”; M
```

```
INPUT “SCIENCE”; S
```

- iii) Use WRITE # or PRINT # Statement to store records.
- iv) Ask for other records.
- v) Close the file.

### **WRITE # statement**

**Purpose:** a file I/O statement that writes data to a sequential file

#### **Syntax:**

#### **WRITE #filename, expressionlist**

- filename is an integer used in an OPEN statement for the file.
- expressionlist is one or more string or numeric expressions, separated by commas.

#### **Example #1:**

```
WRITE #1, N$, A$, E,M,S
```

- It writes (stores) the values stored in the variables N\$,A\$,E,M,S in the file having file number #1. The WRITE # statement puts comma (,) between each field values and encloses the string values by double quotes (“ ”)

### **PRINT # statement**

**Purpose:** a file I/O statement that writes data to a sequential file

#### **Syntax:**

#### **PRINT #filename, expressionlist**

- filename is an integer used in an OPEN statement for the file.
- expressionlist is one or more string or numeric expressions, separated by commas.

#### **Example #2:**

```
PRINT #1, N$, A$, E,M,S
```

- It writes (stores) the values stored in the variables N\$,A\$,E,M,S in the file having file number #1. The PRINT # statement puts some spaces instead of comma (,) between each field values and does not enclose the string values by double quotes (“ ”)

### c) Closing file(s)

You must close the file after read or write into the data file. `CLOSE #` statement is used to close a data file.

#### **CLOSE statement**

**Purpose:** a file I/O statement that concludes I/O to a file

**Syntax:**

**CLOSE [[#]filename[,[#] filename]...]**

- If all arguments are omitted, all open files are closed
- filename is the number of an open file

**Example #1:**

```
CLOSE #1
```

- It closes the file having file number #1.

**Example #2:**

```
CLOSE #1, #2
```

- It closes both files having file number #1 and #2.

**Example #3:**

```
CLOSE
```

- It closes all the files opened in the entire program.

Now, let's practice some programs in computer lab.

**Program #1**

```
OPEN "MARKS.DAT" FOR OUTPUT AS #2
CLS
INPUT "Type Name of student "; n$
INPUT "Type Address "; a$
INPUT "Marks in English "; E
INPUT "Marks in Math "; M
INPUT "Marks in Science "; S
WRITE #2, n$, a$, E, M, S
CLOSE #2
END
```

The above program creates a new file "MARKS.DAT" and stores student's name, address, English, Math and Science stored in n\$, a\$, E, M and S respectively. The program closes the file after storing a record only one time.

**Program #2**

```
OPEN "MARKS.DAT" FOR OUTPUT AS #2
top:
CLS
INPUT "Type Name of student "; n$
INPUT "Type Address "; a$
INPUT "Marks in English "; E
INPUT "Marks in Math "; M
INPUT "Marks in Science "; S
WRITE #2, n$, a$, E, M, S
INPUT "More Records (y/n) "; ans$
IF UCASE$(ans$) = "Y" THEN GOTO top
CLOSE #2
END
```



The above program does the same tasks as Program #1. Additionally, it asks for new records after storing each record. The program will run till the value of ans\$ is “Y” or “y”.

### **Program #3**

```
OPEN "MARKS.DAT" FOR OUTPUT AS #2
FOR i = 1 TO 5
    CLS
    INPUT "Type Name of student "; n$
    INPUT "Type Address "; a$
    INPUT "Marks in English "; E
    INPUT "Marks in Math "; M
    INPUT "Marks in Science "; S
    WRITE #2, n$, E, M, S
NEXT i
CLOSE #2
END
```

The above program stores 5 records.

### **Program #4**

```
OPEN "MARKS.DAT" FOR APPEND AS #3
top:
CLS
INPUT "Type Name of student "; n$
INPUT "Type Address "; a$
INPUT "Marks in English "; E
INPUT "Marks in Math "; M
INPUT "Marks in Science "; S
WRITE #3, n$, a$, E, M, S
INPUT "More Records (y/n) "; ans$
IF UCASE$(ans$) = "Y" THEN GOTO top
CLOSE #2
END
```

The above program opens an existing file “MARKS.DAT” and adds the new records. If the file does not exist, it creates a new file.

#### d) Reading Data from a File

Follow the below steps to read data from a file:

Open the file in INPUT mode.

**Example:**

```
OPEN “MARK.DAT” FOR INPUT AS #7
```

Or

```
OPEN “1” #7, “MARK.DAT”
```

The above statements open the file “MARK.DAT” in INPUT mode so that you can read records from this file.

#### ii) Read records from the file

To read records from an existing file, we use INPUT # statement.

##### INPUT # statement

**Purpose:** a file I/O statement that reads data items from a sequential file and assigns them to variables

**Syntax:**

**INPUT #filenumber, variablelist**

- filenumber is the number of an open sequential file
- variablelist is one or more simple variable names, separated by commas that will be assigned values from the file. Make sure the data type of each variable in the list matches the data type of the incoming data item.

**Example:**

```
INPUT #7, n$, add$, a, b, c
```

**Note:** The number of variables and their types must be matching to the fields of data stored in the data file.

## **LINE INPUT # statement**

**Purpose:** a file I/O statement that reads an entire line without delimiters from a sequential file to a string variable

### **Syntax:**

#### **LINE INPUT #filename, stringvariable**

- filename is the number of an open sequential file
- stringvariable will hold all characters from the current line of the sequential file

### **Example:**

```
LINE INPUT #7, s$
```

## **How to read all the records from a data file?**

INPUT # statement reads one record at a time. Therefore, we have to use a loop to read all the records. The loop should be terminated after reading all the records.

## **EOF (check end of file)**

EOF means END of FILE. It is a function used to check whether the record pointer reaches at end of file or not. When you open a file in INPUT mode, the record pointer points the first record and it is moved to the second record once the first record is read by INPUT # statement. In the same way, if the record reaches at end of file, the EOF function returns TRUE.

## **EOF Statement**

### **Syntax:**

EOF (file number)

### **iii) Display the records on output screen**

Once you read the records using INPUT # statement, they are stored in variables. The next step is to display the data on screen. You can simply use PRINT statement for this purpose.

### **Example:**

```
PRINT n$, add$, a, b, c
```

#### iv) Close the file

Use CLOSE # statement to close the file.

Let's practice some file handling program in the computer lab.

##### **Program #1:**

```
REM Read data from a file
    OPEN "MARKS.DAT" FOR INPUT AS
    #7
    CLS
    WHILE NOT EOF(7)
        INPUT #7, n$, add$, a, b, c
        PRINT n$, add$, a, b, c
    WEND
    CLOSE #7
END
```

The above program opens the file “MARKS.DAT” in input mode and read and displays all the records on the screen.

##### **Program #2:**

```
REM Read data from a file
OPEN "MARKS.DAT" FOR INPUT AS #7
CLS
FOR i = 1 TO 5
    INPUT #7, n$, add$, a, b, c
    PRINT n$, add$, a, b, c
NEXT i
CLOSE #7
END
```

The above program opens the file “MARKS.DAT” in input mode and read the first five record from this file.

**Program #3:**

```
REM Read data from a file
OPEN "MARKS.DAT" FOR INPUT AS #7
CLS
FOR i = 1 TO 5
    LINE INPUT #7, n$
    PRINT n$
NEXT i
CLOSE #7
END
```

The above program opens the file “MARKS.DAT” in input mode. Here, LINE INPUT statement is used to read record. So, each record (single line) is read at a time and stored in n\$. It is used when the number and types of fields of data file are unknown.

**Example 1:**

```
REM To store student's name, class and roll
OPEN "student.txt" FOR OUTPUT AS #5
top:
INPUT "Student's name"; n$
INPUT "Class "; c
INPUT "Roll number "; r
WRITE #5, n$, c, r
INPUT "More records?", y$
IF y$ = "y" THEN GOTO top
CLOSE #5
END
```

## Example 2:

REM To read data from a sequential file

```
CLS
OPEN "student.txt" FOR INPUT AS #7
WHILE NOT EOF (7)
    INPUT #7, a$, b, c
    PRINT a$, b, c
WEND
CLOSE #7
END
```

## INPUT\$ function

**Purpose:** a file I/O function that returns a string of characters read from the specified file

### Syntax:

**INPUT\$(n,[#]filename)**

- n, a numeric expression, is the number of characters to read from the file

### Example:

```
OPEN "student.txt" FOR INPUT AS #2
PRINT INPUT$(12, 2)
```

## Alternative syntax of OPEN statement

### Syntax:

OPEN FILEMODE, filenum, file

### Examples:

```
OPEN "I", 2, "INFO.DAT" is same as OPEN "INFO.DAT" FOR INPUT AS #2
OPEN "O", 3, "INFO.DAT" is same as OPEN "INFO.DAT" FOR OUTPUT AS #3
OPEN "A", 4, "INFO.DAT" is same as OPEN "INFO.DAT" FOR APPEND AS #4
```

## File Management Commands

### a) FILES

**Purpose:** To display the list of files residing on the specified disk

**Syntax:**

FILES [filespec]

- If all arguments are omitted, all files in the current directory are listed
- filespec is a string variable or constant that includes either a filename or pathname and an optional device name

**Example:**

**FILES**

**FILES “\*.bas”** [Lists all files with .bas extension in the current directory]

### b) CHDIR

**Purpose:** To change the current default directory for the specified drive

**Syntax:**

**CHDIR pathspec**

- pathspec is a string expression that identifies the directory that is to become the default directory

**Example:**

**CHDIR “D:\QBASIC”** [Changes the current default directory to D:\QBASIC]

### c) MKDIR

**Purpose:** To create a new directory

**Syntax:**

**MKDIR pathspec**

- pathspec is a string expression that identifies the directory to be created

**Example:**

**MKDIR “d:\QBASIC”** [Creates a directory named QBASIC in D:]

**d) RMDIR**

**Purpose:** To remove an existing empty directory

**Syntax:**

**RMDIR pathspec**

- pathspec is a string expression that identifies the directory to be removed

**Example:**

**RMDIR “d:\QBASIC”** [Removes the directory named QBASIC in D:]

**e) NAME ... AS**

**Purpose:** To change the name of a disk file or directory

**Syntax:**

**NAME old filename AS new filename**

- oldfilename, a string expression, is the name of an existing file.
- newfilename, a string expression, must be a filename that does not exist

**Example:NAME “banepa.bas” AS “dhulikhel.bas”**

[It changes the name of the old file “**banepa.bas**” as new name “**dhulikhel.bas**”]

**f) KILL**

**Purpose:** To delete a file

**Syntax:**

**KILL filespec**

- filespec is a string expression that identifies the file to delete. The filespec may include a path specification.

**Example:**

**KILL “C:\QBASIC\dhulikhel.bas”**

[It erases the file named “dhulikhel.bas” saved inside the directory “**QBASIC**” of drive C:]



**g) SHELL**

**Purpose:** To execute a DOS command

**Syntax:**

**SHELL [commandstring]**

**Example 1:**

**SHELL**

[It displays the DOS prompt window. Now, you can run any DOS command]

**Example 2:**

**SHELL "dir/p"**

[It executes the **DOS** command "**dir/p**" from QBASIC window without opening DOS prompt windows and displays the list of files and sub-directories from the current location page wise.]

**h) SYSTEM**

This command is used to close QBASIC program window.

Example:

**SYSTEM**

**A sample program using file management commands in File handling:**

**Program #1:**

A sequential data file "class.txt" has several records having fields student's name, class and roll number. Write a program to copy all the records from "class.txt" into another new file "student.txt".

```
OPEN "class.txt" FOR INPUT AS #1
```

```
OPEN "student.txt" FOR OUTPUT AS #2
```

```
WHILE NOT EOF (1)
```

```
    INPUT #1, N$, C, R
```

```
    WRITE #2, N$, C, R
```

```
WEND
CLOSE #1, #2
END
```

### Program #2:

A sequential data file "records.txt" has several records having fields Employees' Name, Post and Salary. Write a program to increase the salary of all employees by 10%.

```
OPEN "records.txt" FOR INPUT AS #1
OPEN "temp.txt" FOR OUTPUT AS #2
WHILE NOT EOF (1)
    INPUT #1, E$, P$, S
    WRITE #2, E$, P$, S*1.1
WEND
CLOSE #1, #2
KILL "records.txt"
NAME "temp.txt" AS "records.txt"
END
```

It's not possible to update the records directly in QBASIC. So, a temporary file "temp.txt" is created where all the records of "records.txt" are copied after increasing its salary field by 10%. Finally, the original file "records.txt" is erased and the temporary file "temp.txt" is renamed as "records.txt".

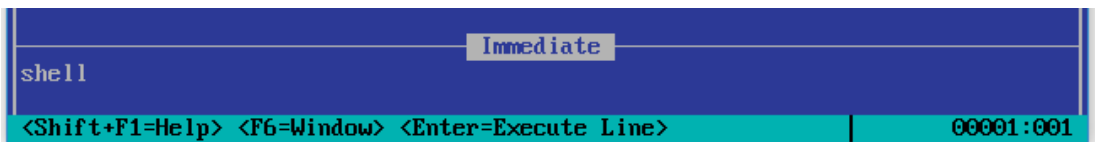

```
Immediate
shell
<Shift+F1=Help> <F6=Window> <Enter=Execute Line> | 00001:001
```

**Note:** Press F6 key to switch between the Main Window and Immediate Window.

## Summary

- File handling is a mechanism to work with file so that we can read and write data from and into a disk file through QBASIC program.
- There are three basic file operations: a) Open the file b) Read/Write data and c) Close the file.
- Output mode creates a new file and opens it to store data.
- Append mode opens an existing file to add records.
- Input mode opens an existing file to read records.
- File must be closed after read or write data.
- Some file management commands are FILES, MKDIR, CHDIR, RMDIR, NAME...AS, KILL and SYSTEM.

## Exercise

### 1. Answer the following questions.

- Define Program File and Data File.
- Explain the different modes used for opening the file.
- What are “Read” and “Write” in data file?
- Explain the below points in short:
  - Opening Data File
  - Closing Data File
- Mention the need of data file in programming.

### 2. Write the syntax and uses of the following statements.

a) OPEN	g) FILES	m) SHELL
b) CLOSE	h) KILL	n) SYSTEM
c) WRITE #	i) MKDIR	
d) PRINT #	j) CHDIR	
e) INPUT #	k) RMDIR	
f) LINE INPUT #	l) NAME ... AS	

**3. Re-Write the below programs after correcting the bugs.**

**a) REM to display all the records from data file ABC.DAT**

```
OPEN "ABC.DAT" FOR OUTPUT AS#1
DO WHILE NOT EOF ("ABC.DAT")
INPUT # 1, N$, A
PRINT N$, A
CLOSE 1
END
```

**b) REM To print only class 10 records from "record.dat"**

```
CLS
OPEN "I", "record.dat" , #2
WHILE NOT EOF (#2)
WRITE #2, n$, c, r
IF c = 10 THEN
PRINT #2, n$, c, r
END IF
WEND
CLOSE #2
END
```

**c) REM To store name and age in a data file**

```
OPEN STD.DOC FOR OUT AS 1
INPUT "ENTER NAME "; N$
INPUT "ENTER AG "; A
WRITE N$, A
CLOSE #1
END
```

**d) OPEN STUDENT.DAT for INPUT #1**

```
DO WHILE NOT EOF (1)
INPUT NAMES$, ADD$, TELNO$, AGE
IF AGE is greater than 15 then
PRINT NAMES$, ADD$, TELNO$, AGE
LOOP
CLOSE #1
END
```

**e) REM to add record in an existing file**

```
CLS
OPEN "Record.Dat" FOR OUTPUT AS #1
AA:
INPUT "Enter Name, Class and Roll No. "; Nm$, Cl, Rn
INPUT #2, Nm$, Cl, Rn
INPUT "More records "; Y$
IF UCASE$(Y$) = "Y" THEN GOTO aa
CLOSE "Rrecord.dat"
END
```

**4. Study the following program and answer the given questions:**

**a) OPEN "data.txt" FOR OUTPUT AS #1**

```
top:
INPUT "Student's Name "; n$
INPUT "Class "; c
INPUT "Roll "; r
WRITE #1, n$, c, r
INPUT "More records ?"; y$
```

```
IF y$ = "y" THEN GOTO top
CLOSE #1
END
```

- i) Why the file is opened in output mode?
- ii) What will happen if the label top: is placed above the OPEN statement?

**b) OPEN "detail.dat" FOR INPUT AS #1**

```
OPEN "temp.dat" FOR OUTPUT AS #2
INPUT "Name of the students "; s$
FOR i = 1 TO 10
INPUT #1, n$, c, a
IF s$ <> n$ THEN
WRITE #2, n$, c, a
END IF
NEXT i
CLOSE #1, #2
KILL "detail.dat"
NAME "temp.dat" AS "detail.dat"
END
```

- i) What is the main objective of the above program?
- ii) Will the program run if the statement KILL "detail.dat" is removed? Why?

## Lab Activities

### Write the QBASIC code for the following problems:

1. Write a program to store records regarding the information of Book number, Book's name and Writer's name in a sequential data file called "Library.dat".
2. Write a program that asks students' name, roll and class and stores into "class.dat" only those records who are studying in class 10. User can supply the records

as per his/her need.

3. Write a program to ask students' name, class, and marks secured in three subjects. Store the data in a sequential data file "RESULT.DAT" along with the total marks. Make a provision to ask the user to enter another record.
4. A sequential data file "student.dat" contains few records under the fields Name, English, Nepali & Computer. Write a program to add few more records in the same sequential data file.
5. A sequential data file "EMP.DAT" contains name, post and salary fields of information about employees. Write a program to display all the information of employee along with tax amount also (tax is 15% of salary)
6. Write a program to create a sequential data file "Employee.Dat" to store employees' Name, Age, Gender and Salary.
7. Write a program to read the data from "INFO.DAT" that contains student name, class, roll no. DOB and address. Write/copy all the data whose DOB is current month to the data file "INFO.DAT".
8. Read information as name, address, roll and salary from "SALARY.DAT" file and display them.
9. A sequential data file "sales.txt" has several records with fields item's name, rate and quantity. Write a program that reads its first 10 records and displays them.
10. A sequential data file "pass.dat" has several records having fields student's name and marks in English, Math and Computer. Write a program that reads all the records and displays only those records whose name starts with 'A' and also counts the total number of records stored in the file.
11. Write a program that asks item's name, rate and quantity and stores into "sales.txt". The user can supply 10 records in each execution of the program.
12. A sequential data file "class.dat" has several records with fields students' name, roll and class. Write a program that reads all the records and displays only those records whose roll number is less than 10.

# Structured Programming in C

---

## 4.1 Introduction

Computer cannot do anything by itself. It requires proper instructions to do any sort of tasks. A set of these instructions is called a program. A program is created to solve a particular task and a group of these programs is called software. We have already known that there are different types of programming language to write programs such as High-Level Language, Assembly Language and Low Level Language. There are several approaches of programming which include Structured, Unstructured, Procedural, Modular, Object Oriented programming etc.

## 4.2 Structured Programming

Structured programming (sometimes known as modular programming) follows a top-down approach, in which programmer separates the overall program structure into different subsections. A defined function or set of similar functions is coded in a separate module or sub module, which means that code can be loaded into memory more efficiently and that modules can be reused in other programs. After a module has been tested individually, it is then integrated with other modules into the overall program structure. Some examples of structured programming languages are Pascal, C, PLII, Ada etc.

## 4.3 Features of Structured Programming:

### a) Top-Down Design

The top-down approach is the process of breaking down the complex problem into simpler ones. In programming also, top-down approach is the stepwise process of breaking down large and complex program into several simpler modules to organize and code in an efficient way.



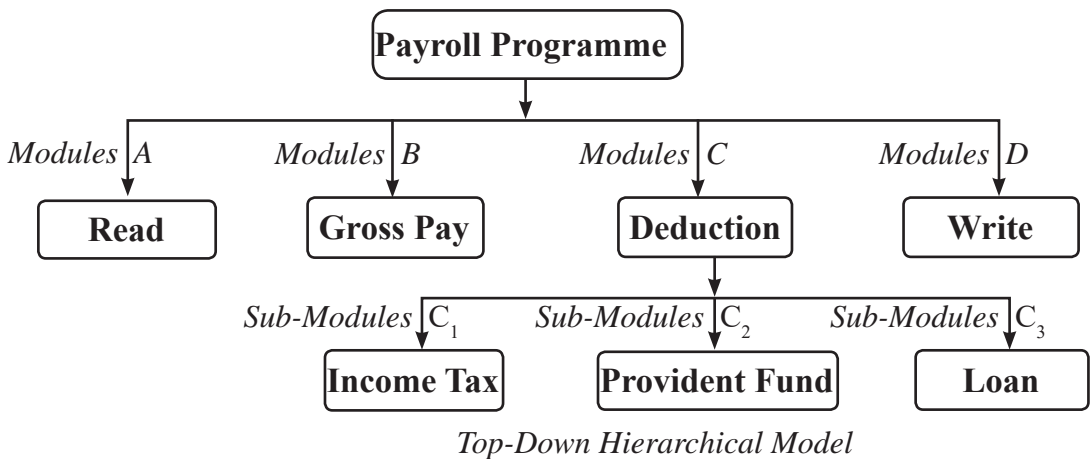

In the above example, the main program is “Payroll” which is broken down into several modules and sub-modules.

### b) Single-Entry, Single-Exit Concept

One of the main features of structured programming is that its modules have only one entry and exit points. It does not support Go To statement. This feature makes easier to understand the flow of control of the program.

Single-Entry, Single-Exit concept can be achieved from the three fundamental Control Structure:

- i) Sequence Structure
- ii) Selection (Branching) Structure
- iii) Loop (Iterations) Structure

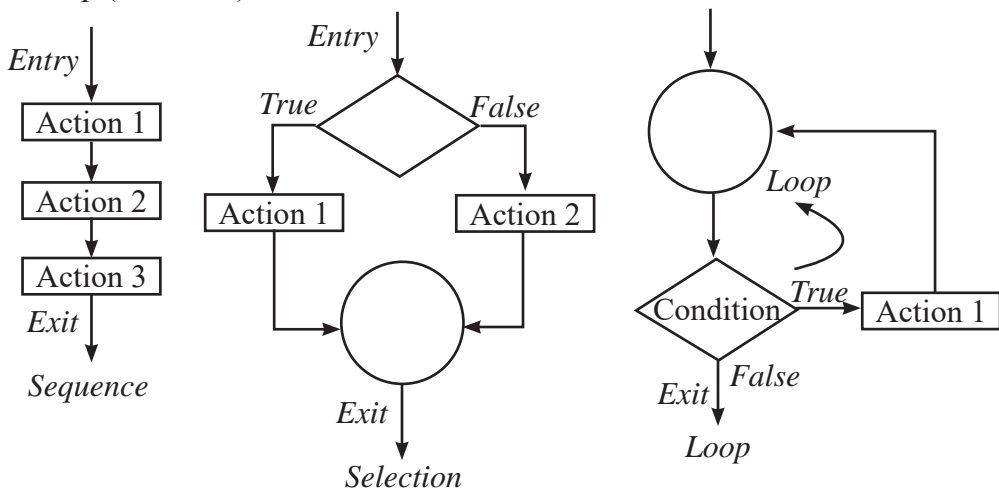

## **Advantages of Structured Programming**

- Reduced Complexity
- Easy to Code
- Take less time
- Easy to debug
- Reuse of modules
- Flow of control is clear

## **C Programming**

### **Introduction**

C Language is a high-level structured programming language. Normally this language is used to develop system software. The C programming language was developed by Dennis Ritchie at Bell Labs during the early 1970s. Quite unpredictably it derived from a computer language named B and from an earlier language BCPL. Initially designed as a system programming language under UNIX, it expanded to have wide usage on many different systems.

### **Features of C Language**

There are certain features of C language. They are:

#### **a) Structured**

C is a Structured Programming Language. Like QBASIC, we break down a program in several small modules in C. The module is called function. It makes the programmer easier to manage and debug the code

#### **b) Middle Level Language**

It combines elements of a high level language with some features of assembler. As a middle level language, C language manipulates memory address.

#### **c) Fast**

It is many time faster than BASIC. Due to the variety of data type and a list of powerful operators, programs written in C are fast and efficient.

#### **d) Case Sensitive**

C is a case-sensitive programming language. It understands the capital alphabets and small alphabets as different values. For example, “Computer” and “COMPUTER” are different values for C Language.

#### **e) Extendable**

C is also an Extendable Programming Language. We can develop functions in C Language and can be added in library for the purpose of using in other programs.

#### **Limitation of C Language**

C has some limitation though it is a powerful programming language. Some of its limitation are:

- a) No Run Time Type Checking
- b) Does not support object oriented programming
- c) C doesn't have the feature of reusability of source code extensively
- d) C language has only 32 Keywords
- e) C provides no data protection
- f) C compilers can only identify errors and are incapable of handling exceptions (run-time errors).

#### **Application of C Language**

C was initially used for system development work, in particular, the programs that make-up the operating system. It is mainly because it produces code that runs nearly as fast as code written in assembly language. But C language is not limited to develop system software.

- a) Operating System
- b) Language Compilers/Interface
- c) Assemblers
- d) Text Editors
- e) Print Spoolers
- f) Network Devices

- g) Modern Programs
- h) DBMS
- i) Utilities etc.

## Data Types in C

C Language supports two types of data:

- a) Basic Data Types
- b) Derived Data Types

Basic Data Types	Derived Data Types
Int (Integer)	Arrays
Char (Character)	Pointers
Float	Structure
Double	Unions
Void	Enums (Enumerations)

## Basic Data Types of C Language

### i) int (Integer)

An Integer is a whole number either positive, negative or zero but no decimal values. For example, 0, -5, 10

### Sub-types of Integer

C supports the different types of integer. Different integer types also have different ranges upto which they can store numbers. These ranges may vary from compiler to compiler. Below is list of ranges along with the memory requirement and format specifies on 32-bit gcc compiler.

Data Types	Storage Size	Range	Format Specifier
short int	2 Bytes	-32,768 to 32,767	%hd
unsigned short int	2 Bytes	0 to 65,535	%hu
unsigned int	4 Bytes	0 to 4,294,967,295	%u
int	4 Bytes	-2,147,483,648 to 2,147,483,647	%d

long int	4 Bytes	-2,147,483,648 to 2,147,483,647	%ld
unsigned long int	4 Bytes	0 to 4,294,967,295	%lu

### Declaring an integer variable

```
int a, b;
```

In the above example, the int keyword is used to declare a and b as integer variables.

```
unsigned int d;
```

Likewise, we can declare integer variable in this way as well.

Here, the type of the variable is declared as unsigned int. It takes 4 bytes of memory and can hold the integers between 0 and 4,294,967,295.

### ii) float

It accepts Floating point values.

Data Types	Storage Size	Range	Digits of Precision	Format Specifier
float	4 Bytes	1.2E-38 to 3.4E+38	6	%f

Declaring float type variable

```
float b;
```

```
b = 1.732;
```

### iii) double

It also accepts the real numbers like float data type but its range is higher than float data type.

Data Types	Storage Size	Range	Digits of Precision	Format Specifier
double	8 Bytes	2.3E-308 to 1.7E+308	15	%fd

Declaring double type variable

```
double x;  
x = 67823.34456;
```

#### iv) **char**

It holds only one character at a time.

<b>Data Types</b>	<b>Storage Size</b>	<b>Format Specifier</b>
char	1 Byte	%c

Declaring char type variable

```
char m;
```

#### **void**

void means “nothing” or “null value”. We cannot create any variable of void type.

For example,

```
void hello (void)  
{  
.....  
}
```

The above function “hello” does not require any parameter and also does not return any value.

#### **C Token**

C tokens are the basic buildings blocks in C language which are constructed together to write a C program. Each and every smallest individual unit in a C program are known as C tokens.

C tokens are of six types. They are:

- a) Keywords (eg: int, while),
- b) Identifiers (eg: main, total),

- c) Constants (eg: 10, 20),
- d) Strings (eg: “total”, “hello”),
- e) Special symbols(eg: (), {}),
- f) Operators (eg: +, /, -, \*)

### **C keywords (reserved word)**

Keywords are a set of special words which are already defined for some tasks. C has only a set of 32 keywords, which have their predefined meaning and cannot be used as a variable name. These words are also known as “reserved words”.

auto	double	int	struct
break	else	long	switch
case	enum	register	typedef
char	extern	return	union
continue	for	signed	void
do	if	static	while
default	goto	sizeof	volatile
const	float	short	unsigned

*Keywords in C Language*

### **C Character set**

Character Set is a group of valid characters and symbols supported by a programming language.

A character denotes any alphabet, digit or special symbol used to represent information. The below table shows the valid alphabets, numbers and special symbols supported by C language.

## Alphabets

Uppercase : A,B,C..... X, Y, Z

Lowercase : a,b,c..... x,y,z

## Digits:

0, 1, 2, 3, 4 ..... 9

## Special characters

,	<	>	.	-	-
(	)	;	\$	:	\
%	[	]	#	?	~
'	&	{	}	"	+
^	!	*	/		

*Special Characters in C Language*

## Identifiers

Identifiers are the names given to the entities such as variables, functions, arrays structures and unions.

For example,

```
int price;  
float total;
```

Here, price and total are called identifiers.

## Rules for naming Identifiers:

- i) The Identifier must start with an alphabet or an under score (\_).
- ii) Identifier can be made from the combination of alphabets, digits and under score.
- iii) No any C keyword can be used as an Identifier.
- iv) Identifier must be unique and can be used for a single purpose only.

## Format Specifier

The format specifier is used during input and output operation. It tells the compiler what



type of data is stored in a variable during the input and output operation such as taking data from keyboard and display data on the screen. Some examples are %c, %d, %f, etc.

<b>Data Type</b>	<b>Format Specifier</b>
short int	%hd
unsigned short int	%hu
unsigned int	%u
int	%d
long int	%ld
unsigned long int	%lu
char	%c
float	%f
double	%lf

## **Variables in C**

A variable is used to hold data within your program. A variable represents a location in your computer's memory. Every variable has two parts, a name and a data type.

### **Variable declaration**

A variable declaration states the types of the variable, variable name and if necessary initializes the variable to a given value.

#### **For e.g.**

```
int count;int number_of_students = 30;
```

Now, let's look a whole program in C:

```

/* This is my C program */
#include <stdio.h>
#include <conio.h>
void main()
{
    int a,b,c;
    printf ("Enter the first number ");
    scanf("%d",&a);
    printf ("Enter the second number ");
    scanf("%d",&b);
    c=a+b;
    printf("Sum = %d",c);
    getch();
}

```

The above C program asks any two numbers from the keyboard and displays their sum. In this program, three variables a,b and c are used and their types are declared as integer (int). Unlike QBASIC, we need to declare the type and name of the variables in the beginning of the program.

## C Program

There are four steps of writing program in C. Each step has its own importance and must be completed stepwise.

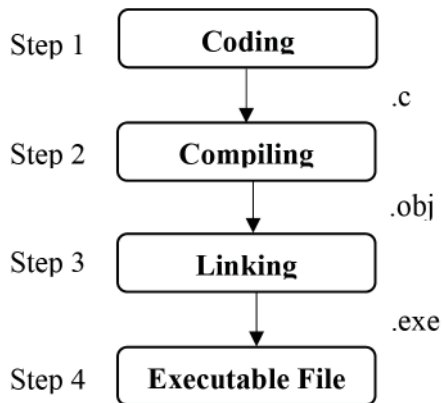

### Step 1:

At first, the program is written in C Compiler editor. It is called source code. This source code can be saved as a program file and its extension is .C. This source code can be edited at any time.

## Step 2:

The second step is to compile the source code. During compilation, syntax error is checked and removed from the source code. After compiling, the source code is changed into binary format and creates a new file with the extension .obj. It is called object program which cannot be edited.

## Step 3:

The third step is called linking process. In this process, the required libraries are linked to the program. Libraries prepare an appropriate environment to execute the C program.

## Step 4:

After the linking process, an executable file is created with the extension .exe. This executable file can be run in any other computer without compiler.

## Structure of C Program

Pre-Processor directives

Global Declarations

main ()

{

Local declarations

Program Statements

Calling user defined for (optional)

}

user defined functions

function 1

function 2

function 3

} *[Optional]*

## Example of a C Program

```
/* To find the product of any two numbers */    → Comments
#include <stdio.h>
#include <conio.h>
void main()
{
    int a,b,c;
    clrscr();
    printf ("Type first number ");
    scanf ("%d",&a);
    printf ("Type second number ");
    scanf ("%d",&b);
    c=a*b;
    printf ("Product = %d",c);
    getch();
}
```

*Pre-processor directives*

*main() function*

**Note:** clrscr() function is similar to CLS statement in QBASIC. It erases the previous contents of the output screen. The clrscr() function is defined in the header file <conio.h>

## Parts of a C Program

### i) Pre-processor directives

As part of compilation, the C compiler runs a program called the C pre-processor. The preprocessor is able to add and remove code from your source file. One of the major functions of C preprocessor is Tokenizing. The final step of the preprocessor is to link the resulting program with necessary programs and library.

While writing program in C, we need to include different header files in the beginning. In the above program, printf ( ) and scanf ( ) functions are used for output and input operation. These functions are defined in the header file <stdio.h>. So, this header file is included at the beginning of program which contains the code of printf() and scanf() functions. All the code of header files will be added to the program during compilation.

## C Header Files

Different library functions are used to do different tasks in C language. For example, we use `scanf()` function to ask data from keyboard. Each function is defined in a special type of file. These files are called Header File and have extension `.h`. These header files must be included using `#include` directive otherwise the compiler doesn't understand the library function we use and gives an error message. Here is the list of some commonly used Header file and their purposes:

Header Files	Purpose	Functions Declared
<code>stdio.h</code>	Used for standard input and output (I/O) operations.	<code>printf()</code> , <code>scanf()</code> , <code>getchar()</code> , <code>putchar()</code> , <code>gets()</code> , <code>puts()</code> , <code>getc()</code> , <code>putc()</code> , <code>fopen</code> , <code>fclose()</code> , <code>feof()</code>
<code>conio.h</code>	Contains declaration for console I/O functions.	<code>clrscr()</code> , <code>exit()</code>
<code>ctype.h</code>	Used for character-handling or testing characters.	<code>isupper()</code> , <code>is lower</code> , <code>isalpha()</code>
<code>math.h</code>	Declares mathematical functions and macros.	<code>pow()</code> , <code>sqr()</code> , <code>cos()</code> , <code>tan()</code> , <code>sin()</code> , <code>log()</code>
<code>stdlib.h</code>	Used for number conversions, storage allocations.	<code>rand()</code> , <code>srand()</code>
<code>string.h</code>	Used for manipulating strings.	<code>strlen()</code> , <code>strcpy()</code> , <code>strcmp()</code> , <code>strcat()</code> , <code>strlwr()</code> , <code>strupr()</code> , <code>strrev()</code>

### ii) Global Directives

In this section of C program, Global variables and User-defined function are declared.

### iii) `main ()` function

C program must start with `main()` function. This is the entry point of the program.

### iv) `{ }` Parenthesis

In C language, each function is defined inside parenthesis (`{ }`).

## v) User-defined function

As in QBASIC, we can create different user-defined function as per our requirements.

### Output Function in C

Output function is used to show the calculated result or output on the screen. In C language, printf() is one of the output function defined in <stdio.h> header file.

#### printf() function

In C Language, printf() function is used to print the valued on the screen. It is defined in <stdio.h> header file. So, the header file <stdio.h> must be added to use this function.

#### Syntax:

```
printf(“format string”,argument list);
```

format string is the combination of format identifier, escape sequence or string constant.

### Escape Sequence

Escape Sequence is a pair of character that is used with printf() function to display non-printing character or a special character on the screen.

Some Examples of Escape Sequence:

\n	-	new line
\t	-	tab
\b	-	backspace
\o	-	null character
\?	-	question mark
\\	-	slash
\'	-	single quote
\”	-	double quote

## Format Identifier

We need to include format identifier to tell the data type in the area of format string of printf() function. For example,

Variable Type	Format Identifier
char	%c
int	%d
long int	%ld
float	%f

## String Constant

String constant is a message to be displayed along with the other values stored in variables. It is enclosed within double quotation (" ").

## Argument List

It is a list of variables to be used in printf ( ) function.

For example,

```
#include <stdio.h>
#include <conio.h>
void main()
{
int a=5,b=10;
clrscr();
printf("\n Value of a and b are %d and %d ",a,b);
getch();
}
```

In the above program,

\n prints from a new line

"Value of a and b are" → String Constant

%d → Format Identifier of int data type

a,b → Arugement List (Variables)

The output of the above program:

```
Value of a and b are 5 and 10
```

**Note:** Each C statement must be terminated by a semicolon(;).

## Input Function in C

Input function is used to ask data for processing. In C language, scanf() is one of the input function defined in <stdio.h> header file.

### scanf() Function

scanf() is one of the most important functions of C Program. This function is also defined in the header file <stdio.h> and used to ask value from keyboard.

### Syntax:

```
scanf("format string", argument list);
```

format string is the combination of format identifier, escape sequence or string constant.



## For example

```
#include <stdio.h>
#include <conio.h>
void main()
{
    int a;
    clrscr();
    printf ("Type an integer ");
    scanf ("%d",&a);
    printf ("\n The value of a is %d.",a);
    getch();
}
```

In the above program,

`scanf ("%d",&a);`

`%d` → Format Identifier of int data type

`&a` → `&` – address operator, `a` – variable

This function in the above program asks an integer from keyboard and stores in the variable ‘a’.

## The output of the above program

```
Type an integer 6
The value of a is 6.
```

## getch() function

`getch()` function is another input function of C language. This function is defined in the header file `<conio.h>`. This function is used to ask any one character from keyboard.

For example,

```
#include <conio.h>
#include <stdio.h>
void main()
{
    char ch;
    clrscr();
    ch=getch();
    printf("The typed character is %c.",ch);
    getch();
}
```

**Note:** You can see the use of getch() function in every example of C program in this book. The purpose of using this function in the sample program is to let the user to read output on the screen. If such type of function is not used, the output screen will be closed immediately after showing the output and returns to the coding window. In the above program, after showing the output by printf() function, getch() asks a character and get chance to see the output until the character is not typed.

### **Arithmetic Calculations in C Program**

There are basically four types of arithmetic operations:

- i) Addition
- ii) Subtraction
- iii) Multiply
- iv) Division

To perform the above arithmetic operations, C language supports the below arithmetic operators:

### **List of Arithmetic Operators in C**

If A=10 and B=20,

<b>Operator</b>	<b>Description</b>	<b>Example</b>	<b>Result</b>
+ (Plus) - Addition	Adds two operands	A+B	30
- (Minus) – Subtraction	Subtracts second operand from first operand	A-B	-10
* (Asterisk) – Multiplication	Multiply two operands	A*B	200
/ (Slash) – Division	Divides first operand by second operand	B/A	2
% (Percentage Symbol) – Modulus Division	Provides remainder when first operand is divided by second operand	B%A	0
++ (Plus Plus) – Increment Operator	Increases the value of operand by 1	A++	11
-- (Minus Minus) – Decrement Operator	Decreases the value of operand by 1	B--	19

## **C Expression**

An expression consists of at least one operand with one or more operators. It is a legal combination of symbols that represents a value.

For example,

$$C=A+B$$

### Example of Arithmetic Calculation #1

```
// Calculate area and volume of a room
#include <stdio.h>
#include <conio.h>
void main()
{
    clrscr();
    int l,b,h,a,v;
    printf ("Type length, breadth and
height ");
    scanf ("%d%d%d",&l,&b,&h);
    a=l*b;
    v=l*b*h;
    printf("\nArea=%d",a);
    printf ("\nVolume=%d",v);
    getch();
}
```

```
// Calculate area and volume of
a room
```

*// is used to write comment as we used REM statement in QBASIC*

*// is used to write comment in a single line*

### Output:

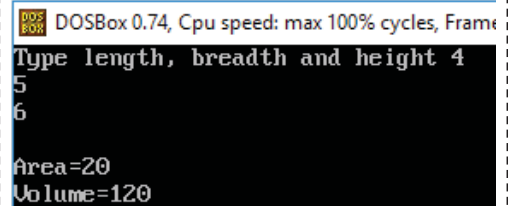

```
DOSBox 0.74, Cpu speed: max 100% cycles, Frame
Type length, breadth and height 4
5
6
Area=20
Volume=120
```

### Example of Arithmetic Calculation #2

```
/* Calculate total marks
and percentage */
#include <stdio.h>
#include <conio.h>
void main()
{
    clrscr();
    int e,m,c,t;
    float p;
    printf("Marks in English, Math &
Computer ");
    scanf("%d%d%d", &e, &m, &c);
    t=e+m+c;
    p=t/3; //Full mark for all subject is
100
    printf("\nTotal Marks = %d ",t);
    printf("\nPercentage = %f ",p);
    getch();
}
```

```
/* Calculate total marks
and percentage */
```

*/\* ... \*/ is also used to write comment in C Language. It is used to write comments in one or more lines.*

### Output:

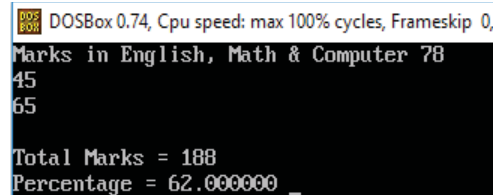

DOSBox 0.74, Cpu speed: max 100% cycles, Frameskip 0,  
Marks in English, Math & Computer 78  
45  
65  
Total Marks = 188  
Percentage = 62.000000 \_

## Logical Calculation in C

The calculation that is done based on one or more conditions is called logical calculations. Several relational or comparison operators are used to check the condition which gives True or False as a calculated result.

## Relational Operators in C

Relational Operator checks the relationship between two operands and returns either 1 (True) or 0 (False). In C programming, relational operators can be used to take decisions and provide condition in looping statements.

## List of Relational Operators in C

If A=5 and B=10,

Operator	Description	Example	Result
==	Equal to	A==B	0
>	Greater than	A>B	0
<	Less than	A<B	1
!=	Not equal to	A!=B	1
>=	Greater than or equal to	A>=B	0
<=	Less than or equal to	A<=B	1

## Control structures in C

C is a structured programming language. Control structures form the basic entities of a “structured programming language“. C supports three types of basic control structures, which are used to alter the flow of execution of the program.

- a) Sequence structure (straight line paths)
- b) Selection structure (one or many branches)
- c) Loop structure (repetition of a set of activities)

### a) Sequential Structure

In sequential structure, the statements are executed one after another sequentially from top to bottom without changing the flow of program.

### b) Selection Structure

It is also called branching structure. In this structure, the control of the program is transferred from one part of the program to another on the basis of specified condition or without condition.

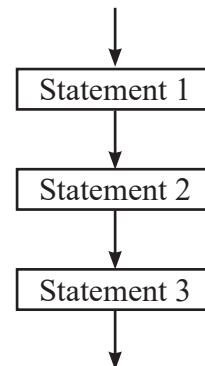

*Flowchart of a sequential structured program*

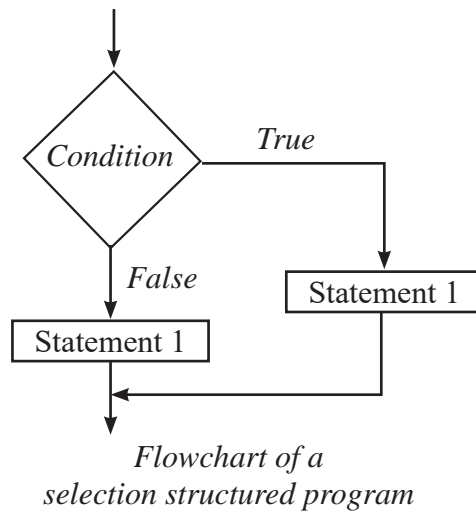

### c) Looping Structure

Looping is the process of repeating the execution of a statement or a block of statements guided by a condition. A loop is terminated when the given condition is satisfied.

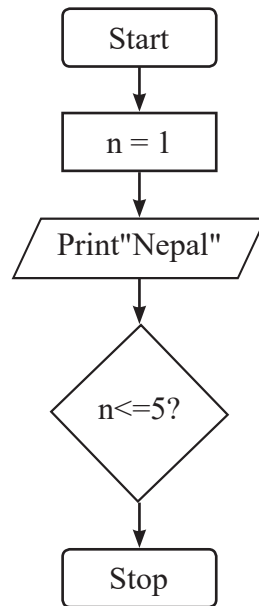

*Flowchart of a looping structured program*

## if statement

if statement is used to test one or more condition and execute statement(s) if the given condition is True.

### Syntax:

```
if (condition)
{
statements
.....
}
```

If the condition mentioned in the syntax is True, then the statements written inside the parenthesis { } will be executed.

### Example:

```
#include <stdio.h>
#include <conio.h>
void main()
{
    int a;
    printf ("Type your marks ");
    scanf ("%d",&a);
    if(a>=40)
    {
        printf ("You are Pass");
        printf ("\nCongratulations!!!");
    }
    getch();
}
```

### Output:

```
The typed character is R.Type your marks 67
You are Pass
Congratulations!!!_
```



## if ... else statement

The previous if statement executes the statement only if the given condition is True. This statement is used to check one or more condition and execute the condition either the condition is True or False.

### Syntax :

```
if (condition)
{
statements
.....
}
else
{
statements
.....
}
```

### Example:

```
#include <stdio.h>
#include <conio.h>
void main()
{
    int a;
    clrscr();
    printf ("Type your marks ");
    scanf ("%d",&a);
    if(a>=40)
    {
        printf ("You are Pass");
    }
    else
    {
        printf ("You are Fail");
    }
    getch();
}
```

### Output:

```
Type your marks 17
You are Fail_
```

In the above program, if the value of a is greater than or equal to 40 then the message “You are Pass” will be printed, otherwise, the program shows “You are Fail”.

#### Example of Logical Calculation #1

```
//Check ODD or EVEN
#include <stdio.h>
#include <conio.h>
void main()
{
    clrscr();
    int n;
    printf("Type any number ");
    scanf("%d",&n);
    if (n%2==0)
    {
        printf ("\nIt is even.");
    }else{
        printf ("\nIt is odd.");
    }
    getch();
}
```

#### Output:

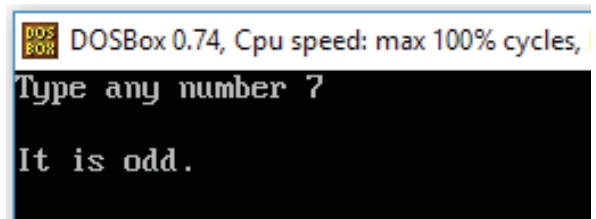
A screenshot of a DOSBox 0.74 terminal window. The title bar reads "DOS BOX DOSBox 0.74, Cpu speed: max 100% cycles, |". The terminal content shows the prompt "Type any number ?" followed by the output "It is odd." on a new line. The background is black with white text.

## Example of Logical Calculation #2

```
/* Find the GREATER number */
#include <stdio.h>
#include <conio.h>
int main()
{
    clrscr();
    int a,b;
    printf("Type first number ");
    scanf("%d",&a);
    printf("Type second number
");
    scanf("%d",&b);
    if(a>b)
    {
        printf("Greater number
is %d ",a);
    }else{
        printf("Greater number
is %d ",b);
    }
    getch();
    return 0;
}
```

## Output:

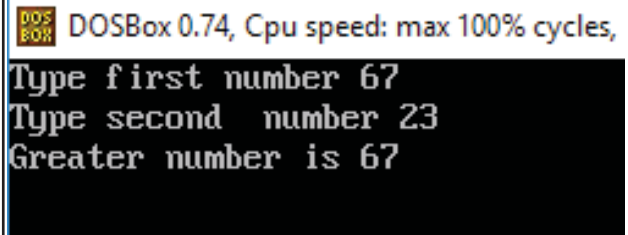

DOSBox 0.74, Cpu speed: max 100% cycles,  
Type first number 67  
Type second number 23  
Greater number is 67

## Looping in C

The looping statement allows a set of instructions to be performed repeatedly until a certain condition is fulfilled. The looping statements are also called iteration statements.

### Looping statements in C

C provides three kinds of loops:

- i) while loop
- ii) do loop
- iii) for loop

#### i) while loop

The while loop continues executing a block of code till the given condition is true. The loop will be terminated when the condition becomes false.

#### Syntax:

```
initial variable declaration
while (condition)
{
statements
.....
// increment of counter
}
```

Example:

```
#include <stdio.h>
#include <conio.h>
void main()
{
    int num=1;
    clrscr();
    while (num<=10)
    {
        printf ("%d ",num);
        num++;
    }
    getch();
}
```

#### Output:

```
1 2 3 4 5 6 7 8 9 10 _
```

In the above program, the value of variable (counter) num is initialized as 1. The loop continues till the values of num is less than or equal to 10. In each iteration (loop), the current value of num is printed and the value of num is increased by 1. When the value of num becomes 11, the condition becomes false and the loop will be terminated.

## ii) do loop

The do loop also executes a block of code as long as a condition is satisfied. The difference between a "do" loop and a "while" loop is that the while loop tests its condition before the execution of loop; the "do" loop tests its condition after the execution of loop.

### Syntax:

```
initial value declaration  
  
do  
{  
statement  
.....  
// increment of counter  
} while (condition);
```

```
#include <stdio.h>  
#include <conio.h>  
void main()  
{  
    int num=1;  
    clrscr();  
    do  
    {  
        printf ("%d ",num);  
        num++;  
    } while (num<=10);  
    getch();  
}
```

### Output:

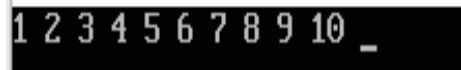

```
1 2 3 4 5 6 7 8 9 10 _
```

## Difference between while/do loop

### iii) for loop

The for loop can execute a block of code for a fixed number of repetitions. It is easy to use and defined in a single statement.

<b>while loop</b>	<b>do loop</b>
Test expression (condition) is checked at first.	Code is executed at first then the condition is checked.
It is also called entry-controlled loop	It is also called exit-controlled loop
elgG5.	elgG5.
<pre>n=1 while (n&gt;10) {     printf ("%d",n);     n++; } Output: Nothing</pre>	<pre>n=1 do {     printf ("%d",n);     n++; } while (n&gt;10); Output: 1</pre>

```
#include <stdio.h>
#include <conio.h>
void main()
{
    clrscr();
    int c;
    for (c=1;c<=10;c++)
    {
        printf ("%d ",c);
    }
    getch();
}
```

**Output:**

```
1 2 3 4 5 6 7 8 9 10 _
```

## Syntax:

for (initialization, condition, increment/decrement )

```
{  
statement  
.....}
```

## Example:

### Use of Loop – Example #1

```
//Fibonacci series 1 2 3 5 8 13 ...
```

```
#include <stdio.h>
```

```
#include <conio.h>
```

```
void main()
```

```
{
```

```
clrscr();
```

```
int a=1,b=2,c,n=1;
```

```
do
```

```
{
```

```
printf ("%d ",a);
```

```
c=a+b;
```

```
a=b;
```

```
b=c;
```

```
n++;
```

```
}while (n<=10);
```

```
getch();
```

```
}
```

## Output:

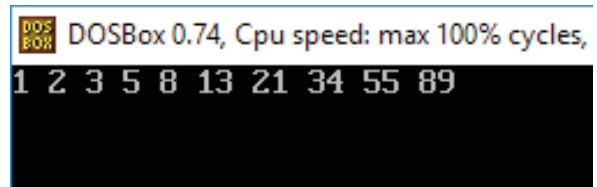

DOSBox 0.74, Cpu speed: max 100% cycles,  
1 2 3 5 8 13 21 34 55 89

## Use of Loop – Example #2

```
//Series 1 2 4 8 ... upto 10th terms
#include <stdio.h>
#include <conio.h>
void main()
{
    clrscr();
    int n=1,c;
    for (c=1;c<=10;c++)
    {
        printf ("%d ",n);
        n=n*2;
    }
    getch();
}
```

### Output:

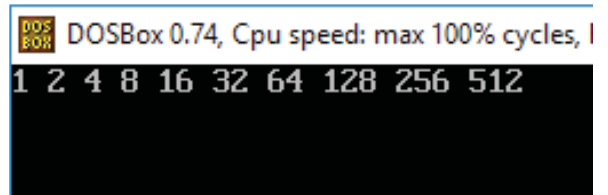

DOSBox 0.74, Cpu speed: max 100% cycles, I  
1 2 4 8 16 32 64 128 256 512



### Use of Loop – Example #3

```
//Check PRIME or COMPOSITE
#include <stdio.h>
#include <conio.h>
void main()
{
    clrscr();
    int n,i,c=0;
    printf ("Type any number ");
    scanf ("%d",&n);
    for (i=2;i<=n-1;i++)
    {
        if(n%i==0) c++;
    }
    if (c==0)
        printf("The number is
prime. ");
    else
        printf("The number is
composite. ");

    getch();
}
```

### Output:

A screenshot of a DOSBox window. The title bar reads "DOSBox 0.74, Cpu speed: max 100% cycles,". The main window area is black with white text. The text displayed is: "Type any number 17" followed by "The number is prime. \_" on the next line. The underscore indicates the cursor position after the program has finished execution.

### Use of Loop – Example #4

```
//Sum of individual digits
#include <stdio.h>
#include <conio.h>
void main()
{
    int n,r,s=0;
    clrscr();
    printf("Type any one integer ");
    scanf("%d",&n);
    while (n!=0)
    {
        r=n%10;
        s=s+r;
        n=n/10;
    }
    printf("Sum of individual digits
= %d",s);
    getch();
}
```

### Output:

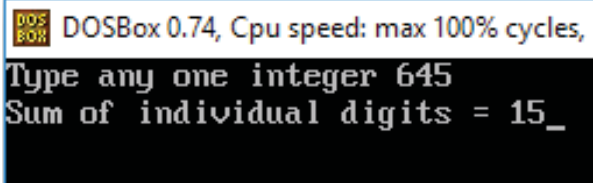

```
DOSBox 0.74, Cpu speed: max 100% cycles,
Type any one integer 645
Sum of individual digits = 15_
```

## Exercises

---

- C is a high-level Structured Programming Language.
- C has only 32 keywords.
- C is a case-sensitive programming language.
- C language is used to develop Operating System, Language Compilers/Interface, Text Editors, Network Devices, Modern Programs, DBMS, Utilities etc.
- C supports two data types: Basic and Derived
- Basic data type includes int, char, float etc.
- Like QBASIC, C program is also written using different control statements such as if statement, looping statement.
- C provides three looping statements: do, while and for.

## Exercises

### 1. Answer the following questions.

- a) What is structured programming? Give any four examples of structured programming language.
- b) Write the advantages of structured programming.
- c) Write the features of C language.
- d) List the data types supported by 'C' language.
- e) Explain the structure of C program.
- f) Differentiate between int and float data type in C.
- g) Explain the different looping statements used in C.

### 2. Fill in the blanks.

- a) Structured Programming is also known as .....
- b) Single-Entry, Single-Exit concept can be achieved from the ..... fundamental Control Structure.
- c) To run any program, we need memory location to store data which is called

- .....
- d) ..... is the name given to any variable, function etc.
  - e) A group of valid characters and symbols supported by C language is called .....
  - f) The printf() function is defined in ..... header file.
  - g) There are basically ..... types of arithmetic operations.
  - h) C language has ..... keywords.

**3. State whether the following statements are 'True' or 'False'.**

- a) Top-Down Design is the process of breaking down the complex problem into simpler ones.
- b) Format specifier tells the type of data stored in a variable during input and output operations.
- c) C is not a case-sensitive language.
- d) C Language has all the features of Object Oriented Programming Language such as Classes, Objects, Inheritance etc.
- e) C language is far closer to the hardware than most other languages.
- f) We use printf() function to ask data from keyboard.
- g) C is a Structured Programming Language.

**4. Re-Write the below programs after correcting the bugs.**

- a) 

```
// Calculate sum of any three numbers
#include <stdio.h>
#include <conio.h>
void main()
{
    clrscr();
    int a,b,c,s;
    printf ("Type any three numbers ");
```

```

scanf ("%f%f%f%f",a,b,c);
s=a+b+c
printf("\nSum=",&s);
getch();
}

```

b) //Series 100 95 90 85 ..... 5

```

#include <stdio.h>
#include <conio.h>
int main()
{
    cls;
    int n=100;
    do
    {
        scanf("%d ",n);
        n=n-5;
    }while(n>=5)
    getch();
}

```

c) //Reverse of an integer

```

#include <stdio.h>
#include <conio.h>
void main()
{
    clrscr();
    int n,r,d;
    printf("Type an integer ");

```

```

scanf("%d",&n);
while(n<>0)
{
d=n mod 10;
r=r*10+d;
n=n/10;
}
printf("\nReversed integer = %d ",d);
}

```

## Lab Activities

### 1. Write the below program in C Language.

- a) Write a program that asks any two numbers and find their sum.
- b) Write a program that asks Principal Amount, Rate and Time and calculates Simple Interest.
- c) Write a program that asks length & breadth of a room and calculates its area and perimeter.
- d) Write a program that asks any two numbers and displays the smaller one.
- e) Write a program to check whether the supplied number is divisible by 7 or not.
- f) Write a program that asks your marks in Computer Science and checks whether you are pass or fail if the pass mark is 40.
- g) Write down C program to generate the below series:
  - i) 5, 10, 15, ..... 50
  - ii) 5, 10, 15, ..... up to 50th terms
  - iii) 1,2,4,8,16, .... up to 10th terms
  - iv) 999, 728, 511, .... up to 10th terms
  - v) 1,2,3,5,8,13,21, .... up to 10th terms

vi) 1  
22  
333  
4444  
55555

- h) Write a program that asks any one integer and calculates the sum of its individual digits.
- i) Write a program that asks any one integer and displays its reverse.
- j) Write a program that asks any one integer and checks whether it is an Armstrong number or not.
- k) Write a program that asks any one integer and calculates its factorial.
- l) Write a program that asks any one integer and displays its factors.
- m) Write a program to check whether the supplied number is prime or composite.

## Technical Terms

---

- Structured Programming : A programming approach to breakdown main program into smaller logical modules
- Top-Down Design : Process of breaking down the complex problem into simpler ones
- Variable : A memory location used to hold data during run-time
- Format Specifier : Tells the type of data stored in a variable during input and output operations
- Identifier : The name given to any variable, function etc.
- C Character Set : A group of valid characters and symbols supported by C language
- Logical Calculation : A type of calculation which is performed based on one or more conditions

## Project Work

---

Accomplish the following tasks and prepare a project report as per the guideline below. The report should include the following parts:

- a) Title page
- b) Acknowledgement
- c) Table of content
- d) Problem statement
- e) Problem analysis
- f) Flowcharts
- g) Program Code
- h) Output (Screenshots)
- i) Limitation of the program
- j) Conclusion

### Project 1:

Develop a menu-based application in QBASIC to do different file handling tasks.

### Sample Menu:

1. Display the records
2. Insert new records
3. Edit a record
Enter Your Choice (1/2/3):
4. Delete records
5. Exit
Choose [1-5]:

### Project 2:

Develop a simple "Contact Management System" in QBASIC with the following features:



- Able to add, view, edit, search and delete contacts.
- The contact details should include name, phone no., address and email.

### **Project 3:**

Develop a simple "Quiz Game" in QBASIC with the following features:

- User will choose a random number between 1 and 10.
- A question will be asked with 4 options.
- Check the answer and award the marks.